



LCD TV

LW32A23W

LW40A23W

Owner's Instructions

Before operating the unit,
please read this manual thoroughly,
and retain it for future reference.

ON-SCREEN MENUS
PC DISPLAY
PICTURE IN PICTURE (PIP)
TELETEXT

Caution

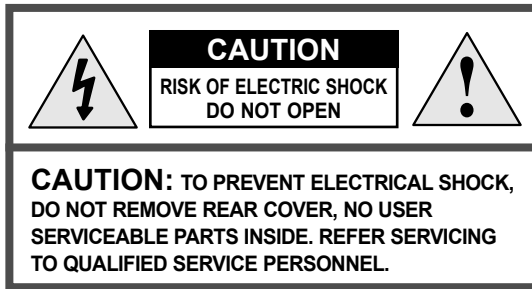

The lightning flash and arrow head within the triangle is a warning sign alerting you of "dangerous voltage" inside the product.

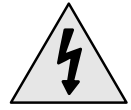

The exclamation point within the triangle is a warning sign alerting you of important instructions accompanying the product.



WARNING: TO PREVENT DAMAGE WHICH MAY RESULT IN FIRE OR SHOCK HAZARD, DO NOT EXPOSE THIS APPLIANCE TO RAIN OR MOISTURE.

 *The main voltage is indicated on the rear of your set and the frequency is 50 or 60 Hz.*

Information in this document is subject to change without notice.
© 2003 Samsung Electronics Co., Ltd. All rights reserved.

Reproduction in any manner whatsoever without the written permission of Samsung Electronics Co., Ltd. is strictly forbidden.

Samsung Electronics Co., Ltd. shall not be liable for errors contained herein or for incidental or consequential damages in connection with the furnishing, performance, or use of this material.

The **Samsung logo** is the registered trademarks of Samsung Electronics Co., Ltd.; **Microsoft, Windows®** and **Windows® NT** are registered trademarks of Microsoft Corporation; **VESA, DPMS** and **DDC** are registered trademarks of Video Electronics Standard Association. All other product names mentioned herein may be the trademarks or registered trademarks of their respective owners.

Plug and Play

The adoption of the new **VESA®** Plug and Play solution eliminates complicated and time consuming setup. It allows you to install your set in a Plug and Play compatible system without the usual hassles and confusion. Your computer system can easily identify and configure itself for use with your set. Your set automatically tells the computer system its **Extended Display Identification Data (EDID)** using **Display Data Channel (DDC)** protocols so the computer system can automatically configure itself to use your set.

Power Saver

This set is **EPA Energy Star®** compliant when used with a computer equipped with **VESA DPMS** functionality. For energy conservation, turn your set Off when you are not using it or when leaving it unattended for long periods.

European Notice (Europe Only)

Products with the CE Marking comply with both the EMC Directive (89/336/EEC), (92/31/EEC), (93/68/EEC) and the Low Voltage Directive (73/23/EEC) issued by the Commission of the European Community. Compliance with these directives implies conformity to the following European Norms:

- EN55022:1998+A1:2000 - Radio Frequency Interference
- EN55024:1998 - Electromagnetic Immunity
- EN55013:1990+A12:1994+A13:1996+A14:1999 - Radio Frequency Interference
- EN55020:1994+A11:1996+A12/A13/A14:1999 - Electromagnetic Immunity
- EN61000-3-2:1995+A1/A2:1998 - Power Line Harmonics
- EN61000-3-3:1995 - Voltage Fluctuations
- EN60065:1997 or EN60950:1998 - Product Safety

Safety Instructions

These illustrations represent precautions concerning your set.

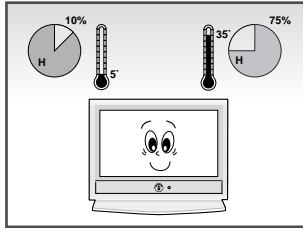

◀ Do NOT expose your set to extreme temperature or humidity conditions.

▶ Do NOT expose your set to direct sunlight.

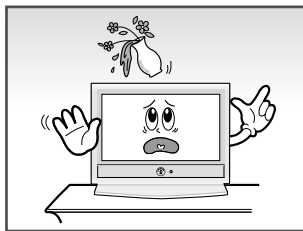
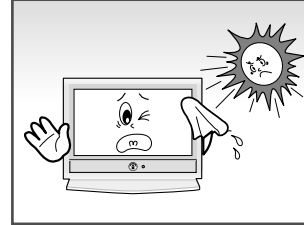

◀ Do NOT expose your set to any liquids.

▶ If your set is broken, do not try to repair it yourself. Contact qualified service personnel.

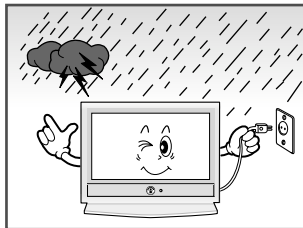
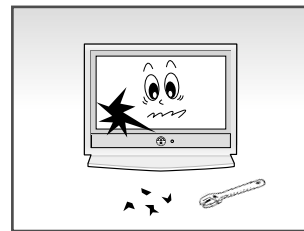

◀ During storm conditions (especially when there is lightning) unplug your set from the mains socket and aerial.

▶ Do not overload wall outlets or extension cord. Possible fire hazard.

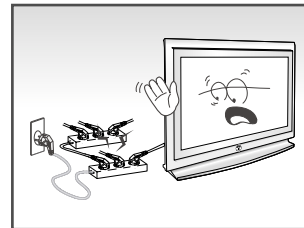

◀ Always keep your set in a well-ventilated area.

▶ Do not step on or twist the power cord.

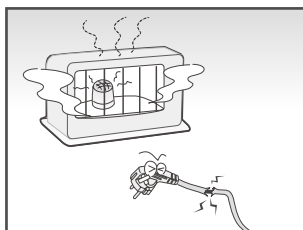
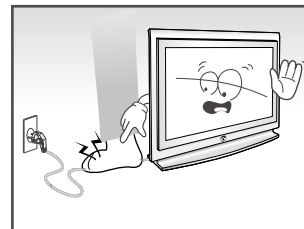

◀ Keep the power cord away from any heat source. Possible fire hazard.

▶ If the remote control is not used for a long period of time, remove the batteries and store it in a cool, dry place.

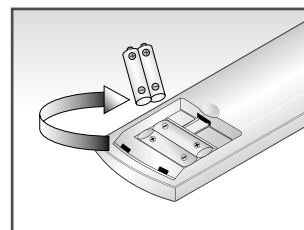

THIS DEVICE IS NOT FOR USE IN INDUSTRIAL ENVIRONMENTS

Contents

◆ FOREWORD	
■ Caution	2
■ Safety Instructions	3
◆ CONNECTING AND PREPARING YOUR TV	
■ Viewing the Control Panel	6
■ Viewing the Connection Panel.....	7
– Connecting an Aerial or Cable Television Network	7
– Connecting Set-Top Box, VCR or DVD	7
– Connecting External A/V Devices	7
– Connecting Component Devices (DTV/DVD)	8
– Connecting Computer	8
– Connecting Digital Audio Inputs	8
– Connecting 5.1 Channel Speakers For Home Theater.....	9
■ Viewing the Remote Control (All Functions Except Teletext).....	10
■ Viewing the Remote Control (Teletext Functions)	11
■ Installing Batteries in the Remote Control	12
■ Switching On and Off.....	13
■ Placing Your Television in Standby Mode.....	13
■ Becoming Familiar with the Remote Control.....	14
■ Plug and Play.....	15
■ Choosing Your Language	16
◆ SETTING THE CHANNELS	
■ Storing Channels Automatically	17
■ Sorting the Stored Channels	18
■ Storing Channels Manually	19
■ Editing the Channels	21
■ Assigning Channels Names	22
■ Fine Tuning Channel Reception.....	23
■ LNA (Low Noise Amplifier)	23
◆ SETTING THE PICTURE	
■ Changing the Picture Standard.....	24
■ Adjusting the Custom Picture	24
■ Changing the Colour Tone.....	25
■ Changing the Picture Size	25
■ Freezing the Current Picture.....	26
■ DNIe (Digital Natural Image engine).....	26
■ Viewing the Picture In Picture (PIP)	27
◆ SETTING THE SOUND	
■ Adjusting the Volume	29
■ Switching the Sound Off Temporarily	29
■ Changing the Sound Standard.....	30
■ Adjusting the Sound Settings.....	30
■ Listening to the Sound of the Sub Picture.....	31

Contents

◆ SETTING THE SOUND (CONTINUED)	
■ Setting the Dolby Digital Surround	32
■ Setting the Dolby Pro Logic II	34
■ Setting the External Digital Sound	35
■ Connecting Headphones	36
■ Adjusting Your Headphone Preferences	36
■ Selecting the Sound Mode	37
◆ SETTING THE TIME	
■ Setting and Displaying the Current Time	38
■ Setting the Sleep Timer	39
■ Switching the Television On and Off Automatically	40
◆ SETTING THE OTHERS	
■ Setting the Blue Screen Mode	41
■ Selecting a Device from External Sources	42
■ Viewing Pictures from External Sources	42
◆ SETTING THE PC	
■ Setting up Your PC Software (Based on Windows 2000 or XP)	43
■ Adjusting the PC Screen Automatically	44
■ Coarse and Fine Tuning of the Image	45
■ Changing the Image Position	46
■ Initializing the Image Settings	46
■ Selecting the DVI Mode	47
◆ USING THE TELETEXT FEATURE	
■ Teletext Decoder	48
■ Displaying the Teletext Information	48
■ Selecting a Specific Teletext Page	49
■ Using FLOF to Select a Teletext Page	50
◆ RECOMMENDATIONS FOR USE	
■ Troubleshooting: Before Contacting Service Personnel	51
■ Installing Stand	52
■ Using the Anti-Theft Kensington Lock	53
■ How to Install the Wall Bracket	54
■ Technical and Environmental Specifications	56
■ Display Mode (PC/DVI)	57
■ Pin Configurations	58
■ Wiring the Mains Power Supply Plug (UK Only)	59
■ Setting Up Your Remote Control	60

Symbols



Press





Important

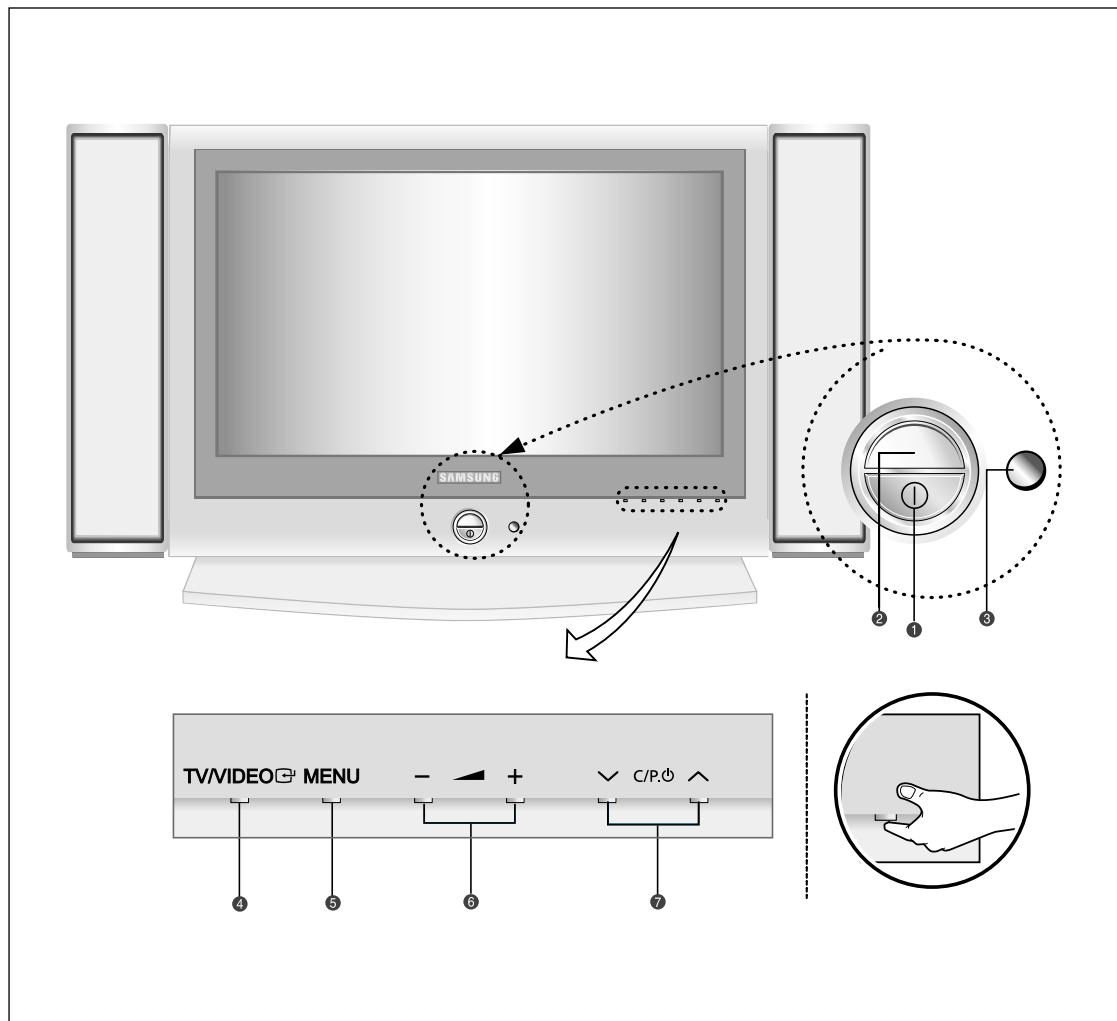

Note

Viewing the Control Panel



- 1** **⏻ (Power)**
Press to turn the TV on and off.
- 2** **Power Indicator**
Lights up when you turn the power off.
- 3** **Remote Control Sensor**
Aim the remote control towards this spot on the TV.
- 4** **TV/VIDEO** 
Displays a menu of all of the available input sources (TV, AV1, AV2, AV3, S-VIDEO, COMP1, COMP2, PC/DVI).

- 5** **MENU**
Press to see an on-screen menu of your TV's features.
- 6** **- ▲ +**
Press to increase or decrease the volume. Also used to select items on the on-screen menu.
- 7** **∨ C/P. ⏻ ^**
Press to change channels. Also press to highlight various items on the on-screen menu.
(Without the Remote Control, You can turn on TV by using the Channel buttons.)

Viewing the Connection Panel

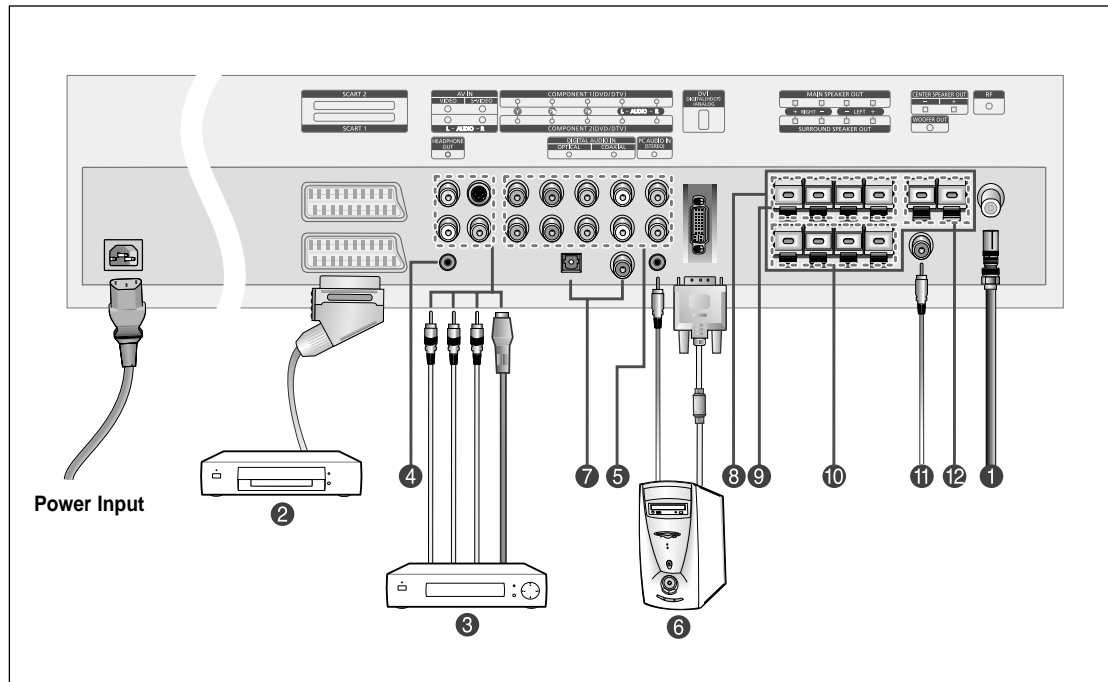

Whenever you connect an audio or video system to your set, ensure that all elements are switched off.

1 Connecting an Aerial or Cable Television Network

To view television channels correctly, a signal must be received by the set from one of the following sources:

- An outdoor aerial
- A cable television network
- A satellite network

2 Connecting Set-Top Box, VCR or DVD

- Connect the VCR or DVD SCART cable to the SCART connector of the VCR or DVD.
- If you wish to connect both the Set-Top Box and VCR (or DVD), you should connect the Set-Top Box to the VCR (or DVD) and connect the VCR (or DVD) to your set.

➤ Input/Output Specification

Connector	Input				Output
	Video	Audio (L/R)	S-Video	RGB	Video+Audio (L/R)
SCART 1	✓	✓		✓	Only TV Out
SCART 2	✓	✓			Monitor Out (TV/AV1/AV2/AV3/S-VHS)

3 Connecting External A/V Devices

- Connect RCA or S-VIDEO cable to an appropriate external A/V device such as VCR, DVD or Camcorder.
- Connect RCA audio cables to "AUDIO(L)" and "AUDIO(R)" on the rear of your set and the other ends to corresponding audio out connectors on the A/V device.
- Headphone may be connected to the headphone output (4) on the rear of your set. *While the headphone is connected, the sound from the built-in speakers will be disabled.*

Viewing the Connection Panel

5 Connecting Component Devices (DTV/DVD)

- Connect component video cables to component connector (“Y”, “Pb”, “Pr”) on the rear of your set and the other ends to corresponding component video out connectors on the DTV or DVD.
- If you wish to connect both the Set-Top Box and DTV (or DVD), you should connect the Set-Top Box to the DTV (or DVD) and connect the DTV (or DVD) to component connector (“Y”, “Pb”, “Pr”) on your set.
- The Y, Pb and Pr connectors on your component devices (DTV or DVD) are sometimes labeled Y, B-Y and R-Y or Y, Cb and Cr.
- Connect RCA audio cables to “AUDIO(L)” and “AUDIO(R)” on the rear of your set and the other ends to corresponding audio out connectors on the DTV or DVD.

Source	Video	Horizontal Frequency (kHz)	Vertical Frequency (Hz)	Resolution (Lines)
TV/VIDEO	PAL	15.625	50	575
	SECAM	15.625	50	575
	NTSC4.43	15.734	60	483
	NTSC3.58 (Except RF)	15.704	60	483
Component 1/2	480/60i	15.734	60	483
	480/60p	31.469	60	483
	576/50i	15.625	50	576
	576/50p	31.250	50	576
	720/60p	45.000	60	720
	1080/50i	28.125	50	1080
	1080/60i	33.750	60	1080

6 Connecting Computer

- Connect the DVI connector to the PC video connector.
- Connect the stereo audio cable to “PC AUDIO IN (STEREO)” on the rear of your set and the other end to “Audio Out” of the sound card on your computer.

7 Connecting Digital Audio Inputs

Connect optical digital audio cable or coaxial cable (RCA audio cable) to “DIGITAL AUDIO IN” on the rear of your set and the other end to “DIGITAL OUT” of the equipment with a digital output to enjoy digital sound (Multi-Channel Surround Sound, Stereo or Dolby Pro-Logic II).

Viewing the Connection Panel

8 Connecting 5.1 Channel Speakers For Home Theater

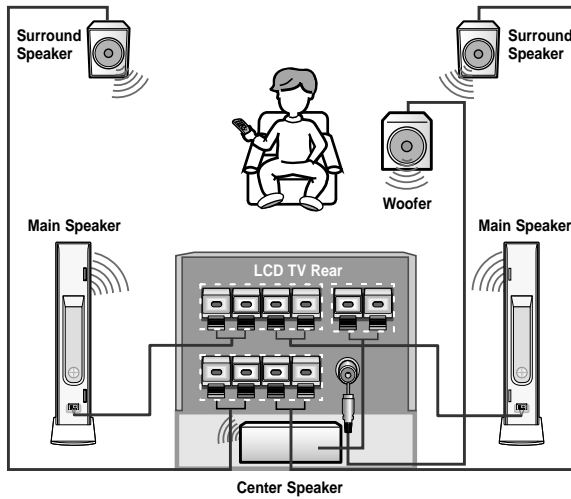

The other speakers (Surround/Center/Sub woofer): Connect the each speaker audio cable to the speaker output jack (surround 10 / Center 12 / Woofer 11) on the rear of your set making sure that the +, - polarities are correctly aligned.

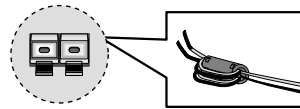

➤ Wind the speaker cable on the core twice or more.

9 Main Speaker : When the speakers are separated from LCD TV

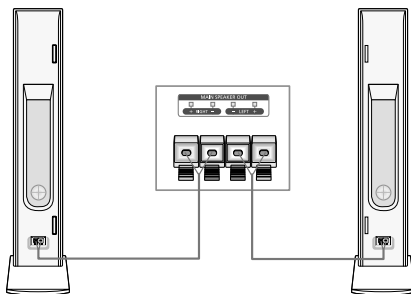

Connect the speaker audio cables to the main speaker output jacks on the rear of your set making sure that the +, - polarities are correctly aligned.

➤ The speakers **MUST** have more than 10watts rating (Impedance 8Ω).

9 Main Speaker : When the speakers are attached with LCD TV

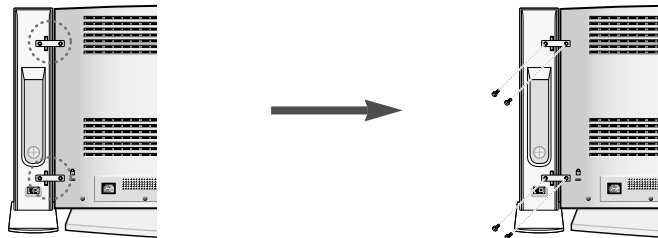

Mount the brackets on the speaker and your set.

Connect the speaker and your set using screws.

Viewing the Remote Control (All Functions Except Teletext)

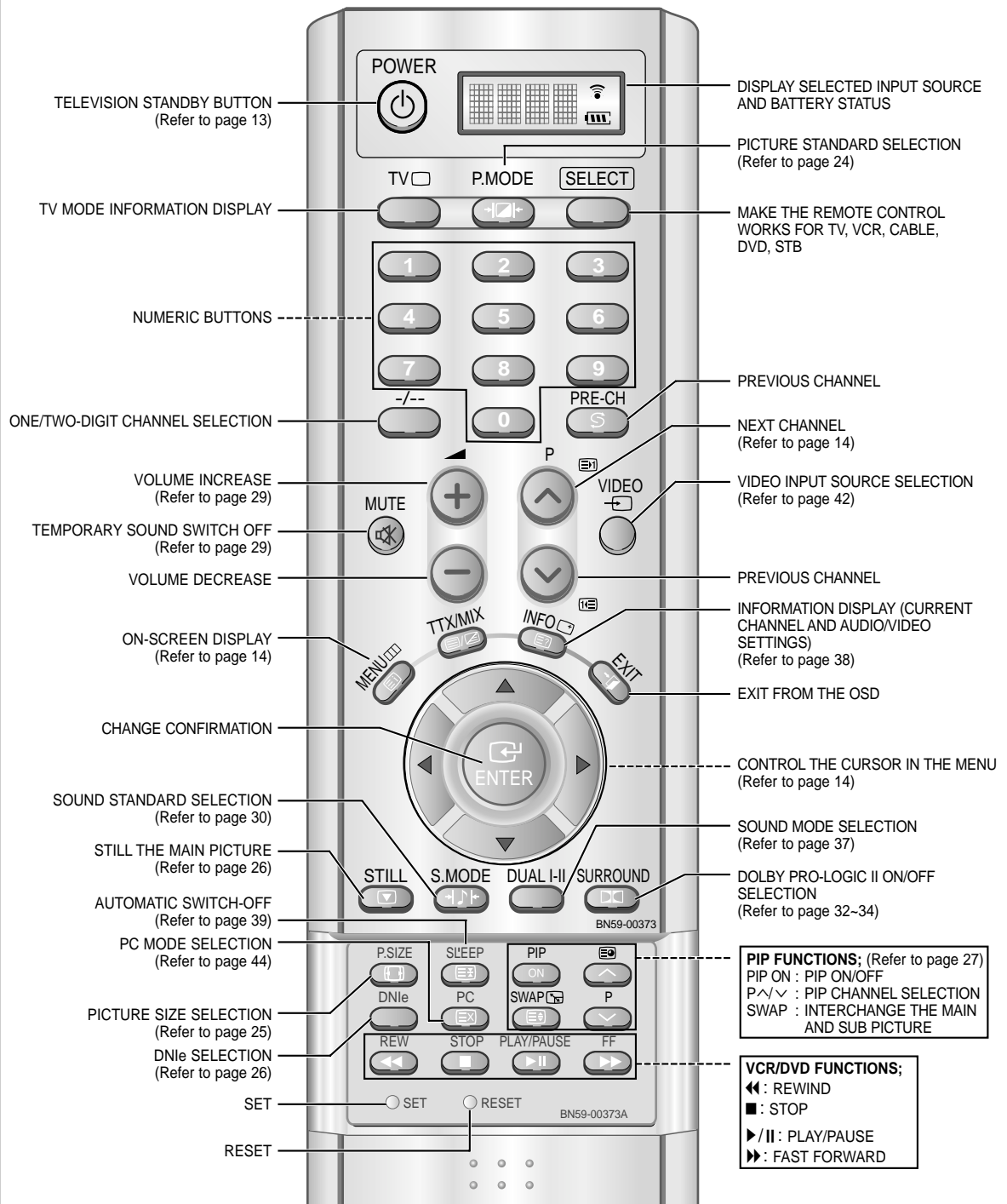

➤ The performance of the remote control may be affected by bright light.

Viewing the Remote Control (Teletext Functions)

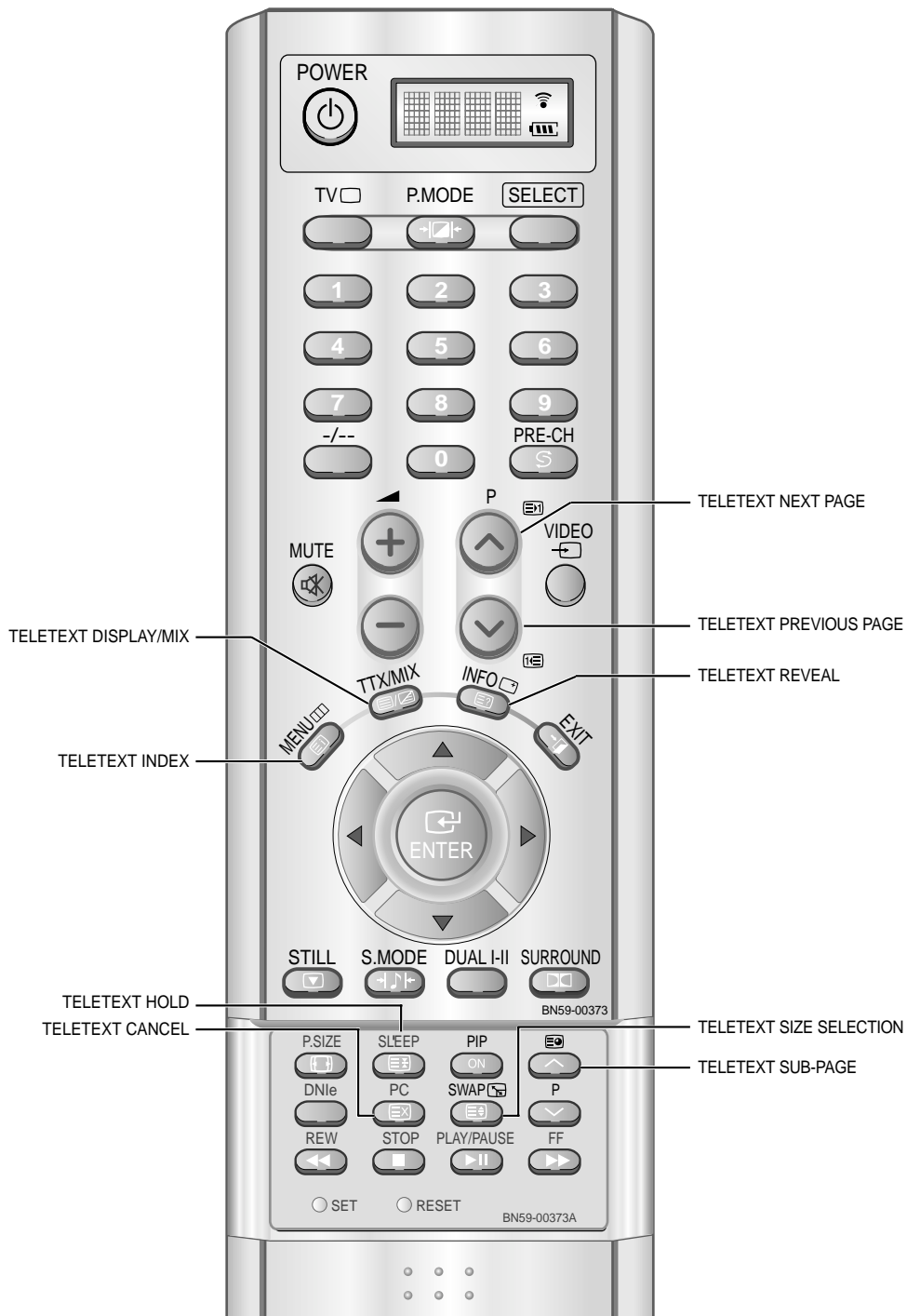

➤ Teletext Function : Refer to page 46-48 for details

Installing Batteries in the Remote Control

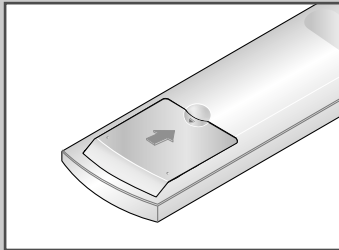
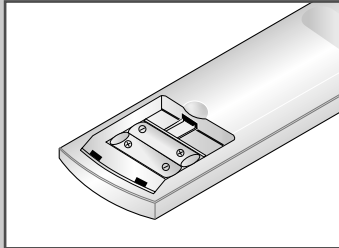
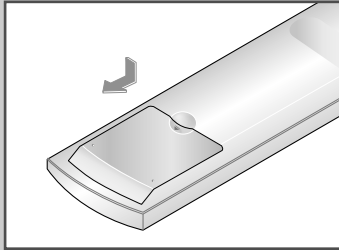

1 Slide the cover out completely.

2 Install two AAA size batteries.

➤ Make sure to match the “+” and “-” ends of the batteries with the diagram inside the compartment.

3 Replace the cover.

➤ Remove the batteries and store them in a cool, dry place if you won't be using the remote control for a long time.

The remote control can be used up to about 23 feet from the TV.

(Assuming typical TV usage, the batteries last for about one year.)

➤ **The remote control doesn't work!**

Check the following:

1. Is the TV power switch on?
2. Is the selected source TV and not video, cable or DVD?
3. Are the plus end and the minus end of the battery reversed?
4. Did the battery run out?
5. Is there a power outage?
6. Is the power cord unplugged?
7. Is there a special fluorescent light or a neon sign nearby?

Switching On and Off

The mains lead is attached to the rear of your set.

- ✎ If you have purchased this set in the United Kingdom, refer to page 59 for further instructions on plug wiring.

- 1 Plug the mains lead into an appropriate socket.
Result: The main voltage is indicated on the rear of your set and the frequency is 50 or 60Hz.
- 2 Press the **POWER** (⏻) button on the front of your set.
Result: The standby indicator lights up on the front panel.
- 3 Press the **POWER** (⏻), numeric button (0-9) or channel up/down (⏮/⏭) button on the remote control or power or **C/P** (⏻) button on the front of your set.
Result: The programme that you were watching last is reselected automatically.
➤ When you switch the set on for the very first time, you will be asked to choose language in which the menus are to be displayed (see page 15).
- 4 To switch your set off, press the **POWER** (⏻) again.

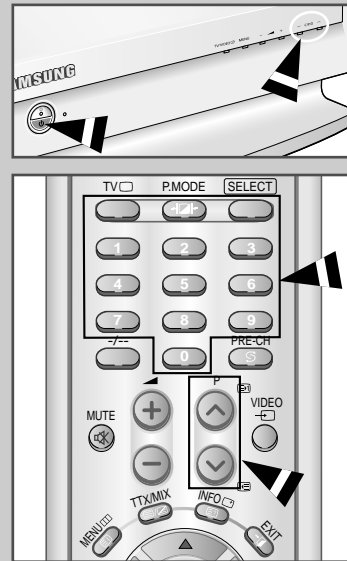

Placing Your Television in Standby Mode

Your set can be placed in Standby mode, in order to reduce the power consumption. The Standby mode can be useful when you wish to interrupt viewing temporarily (during a meal, for example).

- 1 Press the **POWER** (⏻) button on the remote control.
Result: The screen is turned off and a orange standby indicator appears on the front of your set.
- 2 To switch your set back on, simply press the **POWER** (⏻), numeric buttons (0-9) or channel up/down (⏮/⏭) button again.
➤ Do not leave your set in Standby mode for long periods of time (when you are away on holiday, for example). Turn your set off by pressing the **POWER** (⏻) button on the front of the set. It is best to unplug the set from the mains and aerial.
➤ 1. Use of the 'Power' button on the remote is possible only when the TV is in 'Power Saving' (standby) mode. If the TV is powered off, the remote cannot be used to turn the TV on.
2. To retain the time and or automatic alarm settings, always put the TV in stand-by mode with the remote control. Use of the power switch on the TV will clear all time related settings.
[Benefit] This full 'power off' function is as effective as unplugging the power cable.
TV switches to standby mode when powered off by the remote control. To return power (⏻) to the screen, press the remote control 'ON' or channel button (⏮). Pressing the power button on the TV does not return power to the screen because in this case, the TV restores the last mode, which was 'Power Saving'.

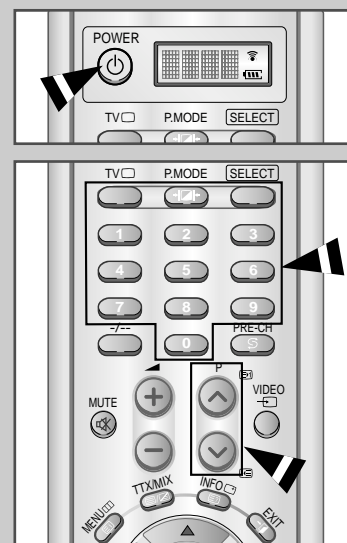

Becoming Familiar with the Remote Control

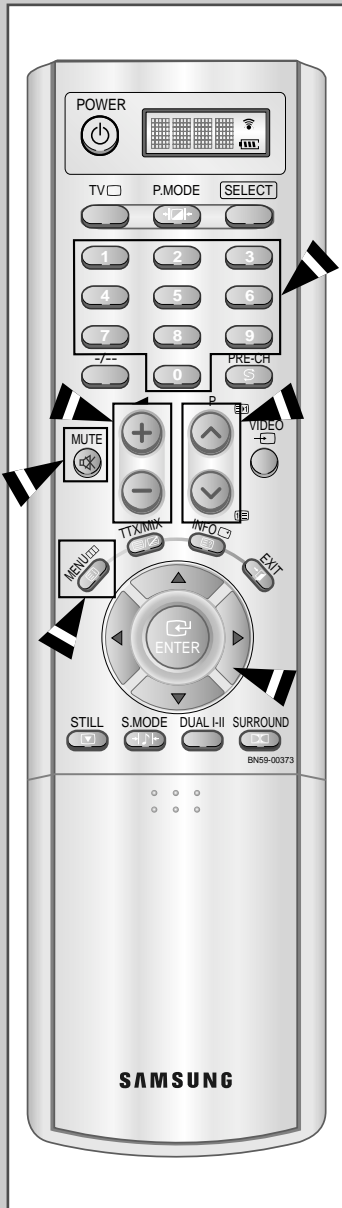

The remote control is used mainly to:

- ◆ Change channels and adjust the volume
- ◆ Set up your set using the on-screen menu system

The following table presents the most frequently used buttons and their functions.

Button	Viewing Function	Menu Function
^	Used to display the next stored channel.	-
v	Used to display the previous stored channel.	-
0 to 9	Used to display the corresponding channels. ➤ For double digit channels, the second digit must be pushed immediately after the first. Failure to do this will result in a single digit channel being displayed.	
-/--	Used to select a channel numbered ten or over. Press this button, and enter the two digit channel number.	
+	Used to increase the volume.	-
-	Used to decrease the volume.	-
MUTE 	Used to switch the sound off temporarily. ➤ To turn the sound back on, press this button again, or press the ▲+/- button.	
MENU 	Used to display the on-screen menu system.	Used to return to the previous menu or normal viewing.
EXIT 	Used to exit the On-Screen menu system.	
	-	Used to: <ul style="list-style-type: none"> ◆ Display a submenu containing selections for the current menu option. ◆ Search forwards/backwards manually for channels ◆ Increase/decrease a menu option value.
ENTER 	-	Used to confirm your choice.

Plug and Play

When the set is initially powered ON, several basic customer settings proceed automatically and subsequently. The following settings are available.

- 1 If the set is in standby mode, press the **POWER** (⏻) button on the remote control.

Result: The message **Plug & Play** is displayed. It appears for a little while, and then the **Language** menu is automatically displayed.

- 2 Select the appropriate **Language** by pressing the ▲ or ▼ button.

➤ The available languages are listed.
You can choose one of 18 Languages.

- 3 Press the **ENTER** (↵) or ► button to confirm your choice.

Result: The message **Ant. Input Check** is displayed with the **OK** is selected.

- 4 Press the **ENTER** (↵) or ► button.

Result: The following countries are available:
**Belgie - Deutschland - Espania - France - Italia -
Nederland - Schweiz - Sverige - UK - East Europe -
Others**

- 5 Select your **Country** by pressing the ▲ or ▼ button.
Press the **ENTER** (↵) or ► button.

Result: The channel search will start and end automatically.

- 6 Select the **Hour** or **Min** by pressing the ◀ or ▶ button.
Set the **Hour/Min** by pressing the ▲ or ▼ button.
(Refer to "Switching the television on and off automatically" on page 40)

- 7 Press the **ENTER** (↵) button to confirm your setting.

Result: The message **Enjoy Your Watching** is displayed, and then the channel which has been stored will be activated.

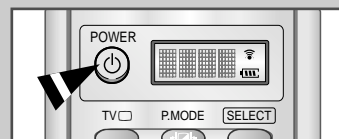

Plug & Play



Ant. Input Check

OK

Clock

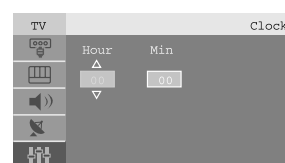

Enjoy Your Watching.

English-15

Plug and Play

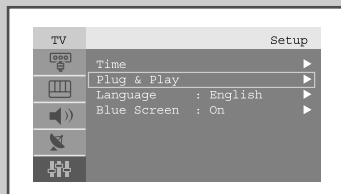
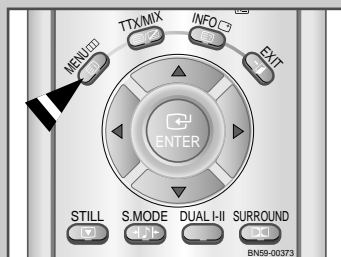

Plug & Play

If you want to reset this feature...

- 1 Press the **MENU** button.
Result: The main menu is displayed.

- 2 Press the **▲** or **▼** button to select **Setup**.
Press the **ENTER**  or **▶** button.
Result: The options available in the **Setup** group are displayed.

- 3 Press the **▲** or **▼** button to select **Plug & Play**.

- 4 Press the **ENTER**  button.
Result: The message is **Plug & Play** displayed.

- 5 For further details on how to set, refer to the previous page.

Choosing Your Language

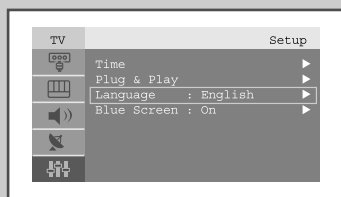



English-16

When you start using your set for the first time, you must select the language which will be used for displaying menus and indications.

- 1 Press the **MENU** button.
Result: The main menu is displayed.

- 2 Press the **▲** or **▼** button to select **Setup**.
Result: The options available in the **Setup** group are displayed.

- 3 Press the **ENTER**  or **▶** button.

- 4 Press the **▲** or **▼** button to select **Language**.
Press the **ENTER**  or **▶** button.
Result: The available languages are listed.

- 5 Select a particular language by pressing the **▲** or **▼** button repeatedly.
Press the **ENTER**  or **▶** button.
➤ You can choose one of 18 Languages.

- 6 When you are satisfied with your choice, press the **EXIT** button to return to normal viewing.

Storing Channels Automatically

You can scan for the frequency ranges available to you (and availability depends on your country). Automatically allocated programme numbers may not correspond to actual or desired programme numbers. However you can sort numbers manually and clear any channels you do not wish to watch.

- 1 Press the **MENU** button.
Result: The main menu is displayed.
- 2 Press the **▲** or **▼** button to select **Channel**.
Result: The options available in the **Channel** group are displayed.
- 3 Press the **ENTER** (↵) or **▶** button.
Result: The **Country** is selected.
- 4 Press the **ENTER** (↵) or **▶** button again. Select your **Country** by pressing the **▲** or **▼** button repeatedly.
The following countries are available:
Belgie - Deutschland - Espania - France - Italia - Nederland - Schweiz - Sverige - UK - East Europe -Others
- 5 Press the **ENTER** (↵) button.
- 6 Press the **▼** button to select **ATM**.
Press the **ENTER** (↵) or **▶** button.
Result: The **start** is selected.
- 7 Press **ENTER** (↵) button to search the channels.
The sub menu is changed from **start** to **stop** with channel search started.
Result: The search will end automatically. Channels are sorted and stored in an order which reflects their position in the frequency range, (with lowest first and highest last). The programme originally selected is then displayed.
 - To return to the previous menu, press **◀** or **▶** button to select **Return** and then press **ENTER** (↵) button.
 - To stop the search before it has finished, press **ENTER** (↵) button with **stop** selected.
- 8 When the channels have been stored, you can:
 - ◆ Sort them in the order required (refer to page 18)
 - ◆ Assign a name to the stored channels (refer to page 22)
 - ◆ Add or delete the channels (refer to page 21)
 - ◆ Fine tune channel reception if necessary (refer to page 23)
 - ◆ Activate the LNA (Low Noise Amplifier) feature (refer to page 23)

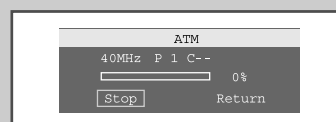
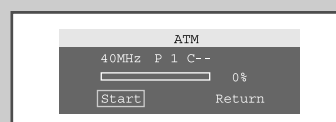
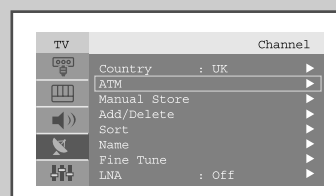
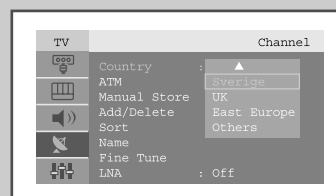
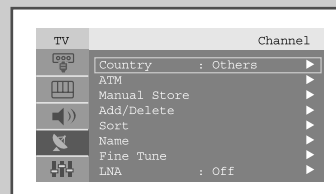

Sorting the Stored Channels

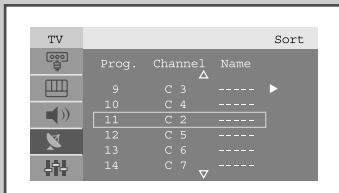
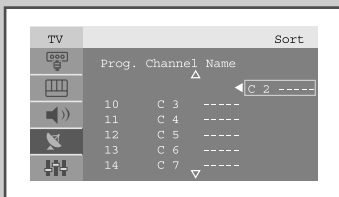
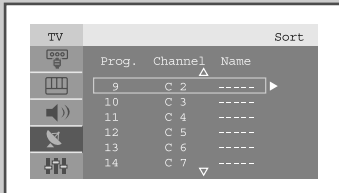
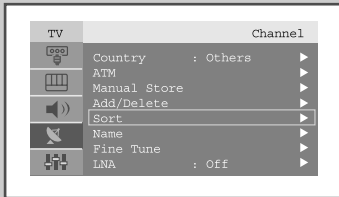
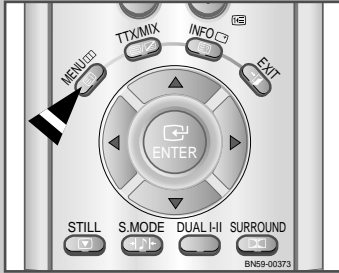

You can exchange the numbers of two channels, in order to:

- ◆ *Modify the numeric order in which the channels have been automatically stored.*
- ◆ *Give easily remembered numbers to the channels that you watch most often.*

- 1 Press the **MENU** button.
Result: The main menu is displayed.

- 2 Press the **▲** or **▼** button to select **Channel1**.
Press the **ENTER** or **▶** button.
Result: The options available in the **Channel1** group are displayed.

- 3 Press the **▲** or **▼** button to select **Sort**.
Press the **ENTER** or **▶** button.
Result: The **Prog.**, **Channel1** and **Name** are displayed.

- 4 Select the **Channel1** number that you wish to change by pressing the **▲** or **▼** button repeatedly.
Press the **ENTER** or **▶** button.
Result: The selected **Channel1** number and **Name** is moved to right side.

- 5 Press the **▲** or **▼** button to move to the position which you would like to change and then press the **ENTER** button.
Result: The selected channel is exchanged with the one previously stored to the chosen number.

- 6 Repeat step 4 to 5 for another channel to sort again.

Storing Channels Manually

You can store up to 100 channels, including those received via cable networks. When storing channels manually, you can choose:

- ◆ Whether or not to store each of the channels found
- ◆ The programme number of each stored channel which you wish to identify

- 1 Press the **MENU** button.

Result: The main menu is displayed.

- 2 Press the **▲** or **▼** button to select **Channel**.

Result: The options available in the **Channel** group are displayed.



- 3 Press the **ENTER**  or **▶** button.

- 4 Press the **▲** or **▼** button to select **Manual Store**. Press the **ENTER**  or **▶** button.



Result: The options available in the **Manual Store** menu are displayed with **Prog.No** selected.

- 5 Press the **ENTER**  button again.

To assign a programme number to a channel, find the correct number by pressing the **▲** or **▼** button and then press the **ENTER**  button.

- 6 Press the **▲** or **▼** button to select **Colour System** and then press the **ENTER**  or **▶** button. Select the **Colour System** required by pressing the **▲** or **▼** button repeatedly and then press the **ENTER**  or **▶** button.

Result: The colour standards are displayed in the following order:
AUTO – PAL – SECAM – NT4.43

- 7 Press the **▲** or **▼** button to select **Sound System** and then press the **ENTER**  or **▶** button. Select the sound standard required by pressing the **▲** or **▼** button repeatedly and then press the **ENTER**  or **▶** button.

Result: The sound standards are displayed in the following order:
BG – DK – I – L

- 8 For all the channels to move to the required channel numbers, repeat steps 5 to 7 after selecting **Prog.No** by pressing **▲** or **▼** button.

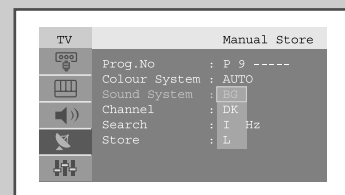
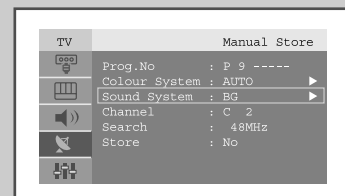
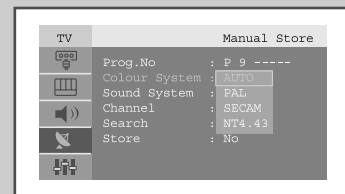
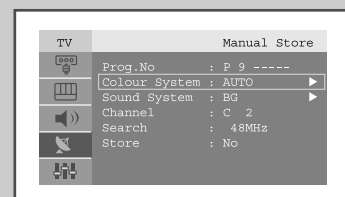
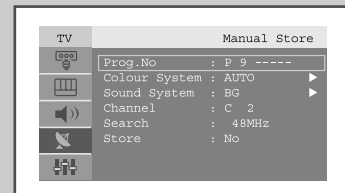
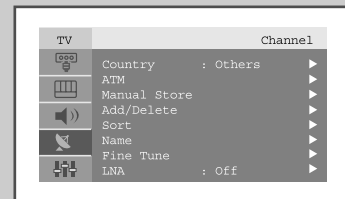

Storing Channels Manually (continued)

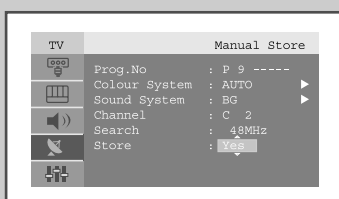
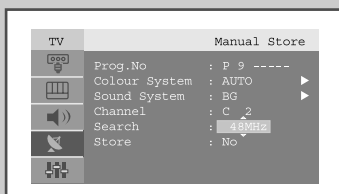
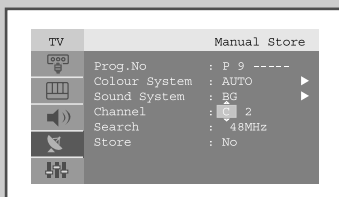

- 9** If you know the number of the channel to be stored...
- ◆ Press the ▲ or ▼ button to select **Channel** and then press the **ENTER** or ► button.
 - ◆ Select **C** (Air channel) or **S** (Cable channel) by pressing the ▲ or ▼ button and then press the **ENTER** or ► button.
 - ◆ Select the required number by pressing the ▲ or ▼ button and then press the **ENTER** or ► button.
- If there is abnormal sound or no sound, re-select the sound system required.
-
- 10** If you do not know the channel numbers, press the ▲ or ▼ button to select **Search** and then press the **ENTER** or ► button. **Search** by pressing ▲ or ▼ button and then press the **ENTER** or ► button.
- Result:** The tuner scans the frequency range until the first channel or the channel that you selected is received on your screen.
-
- 11** Press the ▲ or ▼ button to select **store** and then press the **ENTER** or ► button. Select **Yes** by pressing the ▲ or ▼ button and then press the **ENTER** or ► button.
- Result:** The channel and associated programme number are stored.
-
- 12** Repeat Steps **9** to **11** for each channel to be stored.

☞ Channel mode

- ◆ **P** (Programme mode): When tuning is completed, the broadcasting stations in your area will have been assigned to position numbers from P00 to P99. You can select a channel by entering the position number in this mode.
- ◆ **C** (Real channel mode): You can select a channel by entering the assigned number to each broadcast station in this mode.
- ◆ **S** (Cable channel mode): You can select a channel by entering the assigned number to each cable channel in this mode.

Editing the Channels

You can exclude the channels you chosen from the channels you scanned. When you scan through the stored channels, those you have chosen to skip are not displayed.

All channels that you do not specifically choose to skip are displayed during scanning.

- 1 Press the **MENU** button.
Result: The main menu is displayed.

- 2 Press the **▲** or **▼** button to select **Channel**.
Press the **ENTER**  or **▶** button.
Result: The options available in the **Channel** group are displayed.

- 3 Press the **▲** or **▼** button to select **Add/Delete**.
Press the **ENTER**  or **▶** button.
Result: The state of current channel is displayed.

- 4 Press the **∧/∨** button to select **Channel** that you wish to **Add** or **Delete**.
Result: If the channel that you wish to edit is not in memory, the **Add** is selected and displayed.
Otherwise, if the channel that you wish to edit is in memory, the **Delete** is selected and displayed.

- 5 Press the **ENTER**  button to **Add** or **Delete** channel.

- 6 To return to the previous menu, select **Return** by pressing the **◀** or **▶** button and then press the **ENTER**  button.

- 7 Repeat Step 4 and 6 for each channel to be added or deleted.

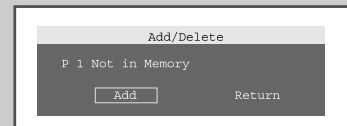
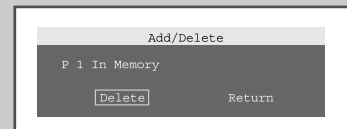
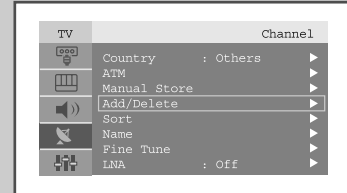
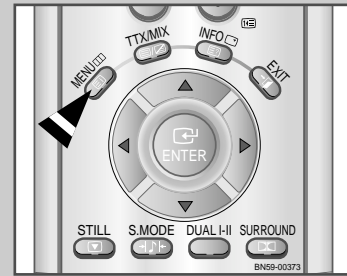

Assigning Channels Names

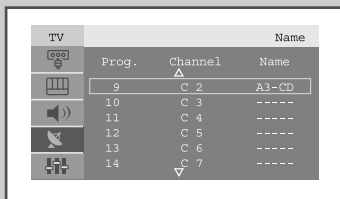
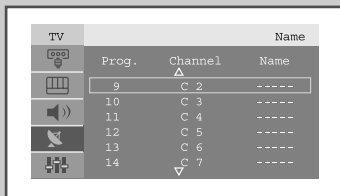
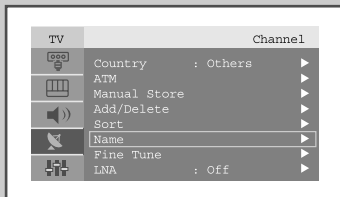
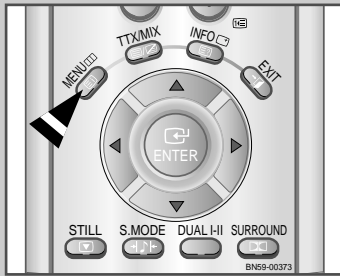





Channel names will be assigned automatically when channel information is broadcast. These names can be changed, allowing you to assign new names.

- Press the **MENU** button.
Result: The main menu is displayed.
 - Press the **▲** or **▼** button to select **Channel1**. Press the **ENTER** or **▶** button.
Result: The options available in the **channel1** group are displayed.
 - Press the **▲** or **▼** button to select **Name**. Press the **ENTER** or **▶** button.
Result: The current **Prog.**, **Channel** and **Name** are displayed.
 - If necessary, select the channel to be assigned to a new name by pressing the **▲** or **▼** button. Press the **ENTER** or **▶** button.
Result: The selection bar is displayed around the name box.
- | 5 | To... | Then... |
|---|-----------------------------------|---------------------------------------|
| | Select a letter, number or symbol | Press the ▲ or ▼ button |
| | Move on the next letter | Press the ▶ button |
| | Move back the previous letter | Press the ◀ button |
| | Confirm the name | Press the ENTER button |
- The characters available are :
- ◆ Letters of the alphabet (A~Z)
 - ◆ Numbers (0~9)
 - ◆ Special characters (–, space)
- Repeat Steps 4 to 5 for each channel to be assigned to a new name.
 - When you have finished entering the name, press the **ENTER** button to confirm the name.

Fine Tuning Channel Reception

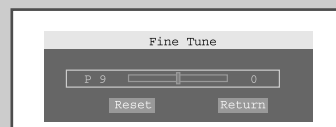
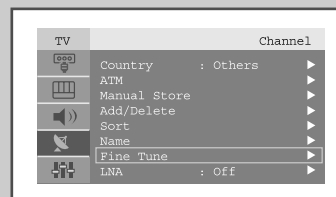

If the reception is clear, you do not have to fine-tune the channel, as this is done automatically during the search and store operation. If however the signal is weak or distorted, you may have to fine-tune the channel manually.

- 1 Press the **MENU** button.
Result: The main menu is displayed.
- 2 Press the **▲** or **▼** button to select **Channel**.
Press the **ENTER**  or **▶** button.
Result: The options available in the **Channel** group are displayed.
- 3 Press the **▲** or **▼** button to select **Fine Tune**.
Press the **ENTER**  or **▶** button.
- 4 Press the **∧/∨** button to select the channel that you wish to fine tune.
- 5 Press **◀** or **▶** button until you reach the setting to obtain a sharp and clear picture and good sound quality.
To store the setting, press the **ENTER**  button.
- 6 To reset the fine tuning, select **Reset** by pressing **▲** or **▼** button and then press the **ENTER**  button.
To return to the previous menu, select **Return** by pressing **◀** or **▶** button and press the **ENTER**  button.



LNA (Low Noise Amplifier)

If the set is operating in a weak-signal area, sometimes the LNA function can improve the reception.

- 1 Press the **MENU** button.
Result: The main menu is displayed.
- 2 Press the **▲** or **▼** button to select **Channel**.
Press the **ENTER**  or **▶** button.
Result: The options available in the **Channel** group are displayed.
- 3 Press the **▲** or **▼** button to select **LNA**.
Press the **ENTER**  or **▶** button.
Result: The **LNA** menu is displayed.
- 4 Select **On** by pressing **▲** or **▼** button.
Result: Amplifies signals when antenna reception is poor. However if incoming signals are interfering with each other, turn off **LNA** as it may malfunction.
- 5 When it has finished, press the **EXIT** button to return to normal viewing.

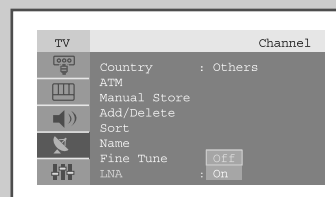

Changing the Picture Standard

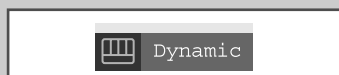
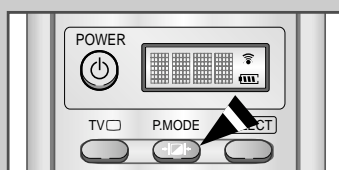
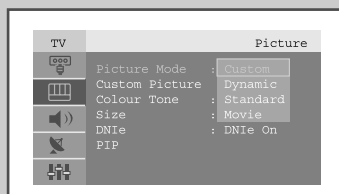
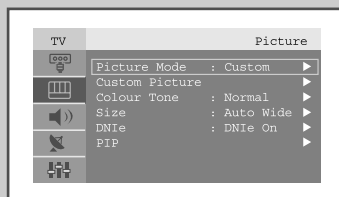

You can select the type of picture which best corresponds to your viewing requirements.

- 1 Press the **MENU** button.
Result: The main menu is displayed.
- 2 Press the **▲** or **▼** button to select **Picture**.
Result: The options available in the **Picture** group are displayed.
- 3 Press the **ENTER** or **▶** button.
Result: The **Picture Mode** is selected.
- 4 Press the **ENTER** or **▶** button again.
Select the required picture effect by pressing the **▲** or **▼** button repeatedly. The following picture effects are available:

Custom - Dynamic - Standard - Movie

- You can also display simply by pressing the **P.MODE** (Picture Mode) button.

Adjusting the Custom Picture

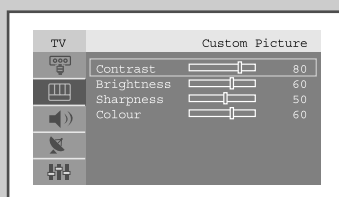
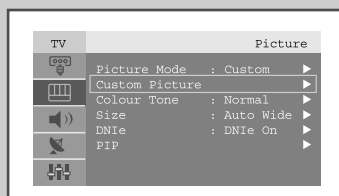

Your set has several settings which allow you to control picture quality.

- 1 Press the **MENU** button.
Result: The main menu is displayed.
- 2 Press the **▲** or **▼** button to select **Picture**.
Result: The options available in the **Picture** group are displayed.
- 3 Press the **ENTER** or **▶** button.
- 4 Press **▲** or **▼** button to select **Custom Picture** and press the **ENTER** or **▶** button.
- 5 Select the option (**Contrast**, **Brightness**, **Sharpness**, **Colour** or **Tint-NTSC** only) to be adjusted by pressing the **▲** or **▼** button.
Press the **ENTER** or **▶** button.
Result: The horizontal bar is displayed.
- 6 Press the **◀** or **▶** button to reach the required setting.
- 7 When you are satisfied with the setting, press the **MENU** button to return to the previous menu or press the **EXIT** button to return to normal viewing.

Changing the Colour Tone

You can select the most comfortable colour tone to your eye.

- 1 Press the **MENU** button.
Result: The main menu is displayed.
- 2 Press the **▲** or **▼** button to select **Picture**.
Result: The options available in the **Picture** group are displayed.
- 3 Press the **ENTER** (↵) or **▶** button.
- 4 Press the **▲** or **▼** button to select **Colour tone** and press **ENTER** (↵) or **▶** button. Select the required option by pressing the **▲** or **▼** button repeatedly. The following options are available:
Cool2 - Cool1 - Normal - Warm1 - Warm2
- 5 When you are satisfied with your choice, press the **EXIT** button to return to normal viewing.

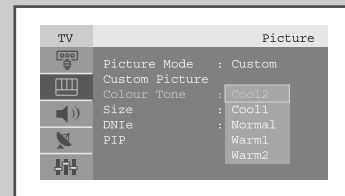
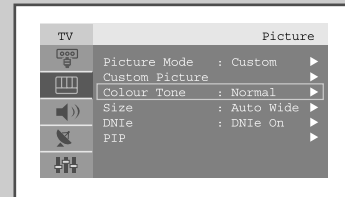

Changing the Picture Size

You can select the picture size which best corresponds to your viewing requirements.

- 1 Press the **MENU** button.
Result: The main menu is displayed.
- 2 Press the **▲** or **▼** button to select **Picture**.
Result: The options available in the **Picture** group are displayed.
- 3 Press the **ENTER** (↵) or **▶** button.
- 4 Press **▲** or **▼** button to select **size** and press the **ENTER** (↵) or **▶** button.
- 5 Select the required option by pressing the **▲** or **▼** button repeatedly. The following options are available:

AutoWide - Wide - Panorama - Zoom1 - Zoom2 - 4:3

- ◆ You can select these options by simply pressing the **P.SIZE**(Picture Size) button on the remote control.
- ◆ This feature does not work when the PIP feature is activating.
- ◆ When the picture size is selected to Auto Wide, the PIP feature will work.

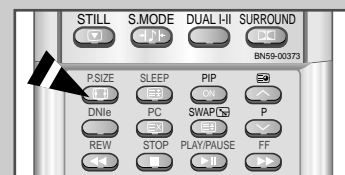
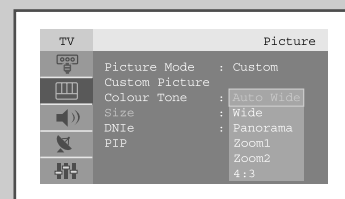
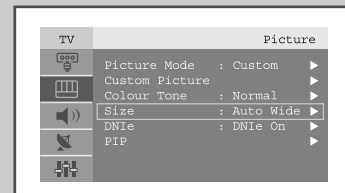

Auto Wide

Freezing the Current Picture

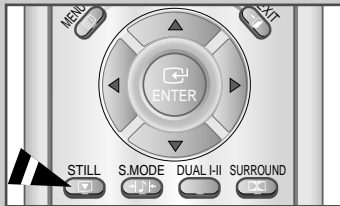



Press the "STILL" button to freeze a moving picture into a still one. Press again to cancel.

- This function will not operate in the PC Mode. NT4.43 is not supported in the sub-display.

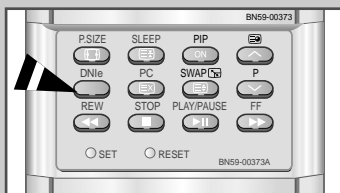
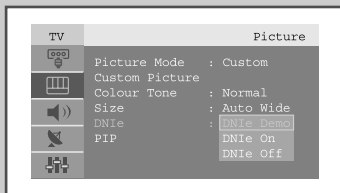
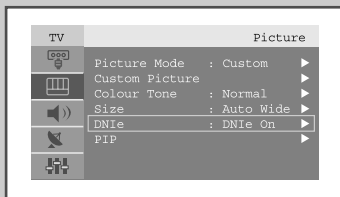
DNle (Digital Natural Image engine)



Samsung's New Technology brings you more detailed images with contrast and white enhancement. A new image compensation algorithm gives viewers brighter and clearer image. DNle technology will match every signal to your eye.

- 1 Press the **MENU** button.
Result: The main menu is displayed.
- 2 Press the **▲** or **▼** button to select **Picture**.
Result: The options available in the **Picture** group are displayed.
- 3 Press the **ENTER**  or **▶** button.
- 4 Press the **▲** or **▼** button to select **DNle** and then press the **ENTER**  or **▶** button.
Select the required option by pressing the **▲** or **▼** button.
The following options are available:
 - You can also select these options by simply pressing the **DNle** button.
- 5 When you are satisfied with your choice, press the **EXIT** button to return to normal viewing.

- **DNle Demo** The screen shows the improved image on the left-hand side and the original image on the right-hand side.
- DNle On** Improved picture mode demonstrated by DNle Demo is activated.
- DNle Off** The mode is deactivated and the screen returns to its original condition.

Viewing the Picture In Picture (PIP)

You can display a sub picture within the main picture of set program or video input. In this way you can watch or monitor set program or the video input from any connected equipment while watching set or other video input.

- 1 Press the **MENU** button.

Result: The main menu is displayed.

- 2 Press the **▲** or **▼** button to select **Picture**.

Result: The options available in the **Picture** group are displayed.

- 3 Press the **ENTER** or **▶** button.

- 4 Press the **▲** or **▼** button to select **PIP** and then press the **ENTER** or **▶** button.

Result: The options available in the **PIP** menu are displayed.

- 5 Press the **ENTER** or **▶** button again. Select **On** by pressing the **▲** or **▼** button and then press the **ENTER** or **▶** button.

- 6 Press the **▲** or **▼** button to select **TV/Video** and press **ENTER** or **▶** button. Select a source of the sub picture by pressing the **▲** or **▼** button and press the **ENTER** or **▶** button.

Result: The sources are displayed in the following order:
TV - AV1 - AV2 - AV3 - S-Video - Comp1 - Comp2

- 7 To interchange the main picture and the sub picture, select **SWAP** option and press the **ENTER** or **▶** button.

Result: The main picture and the sub picture are interchanged.

- 8 Press the **▲** or **▼** button to select **size** of sub picture and then press the **ENTER** or **▶** button.

Select a size of the sub picture by pressing the **▲** or **▼** button and then press the **ENTER** or **▶** button.

Result: The sizes are displayed in the following order:

 **Small** -  **Double1** -  **Double2**

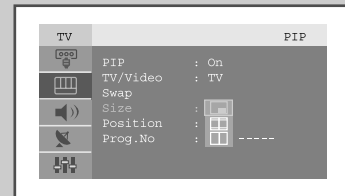
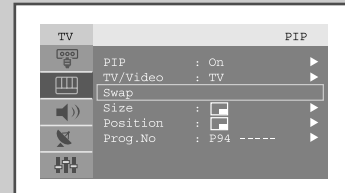
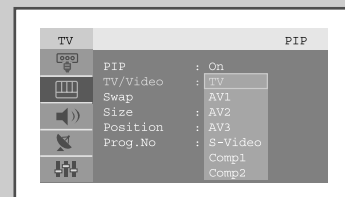
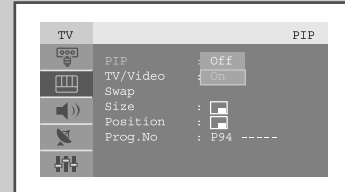
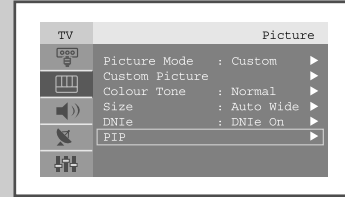

Viewing the Picture In Picture (PIP) (continued)

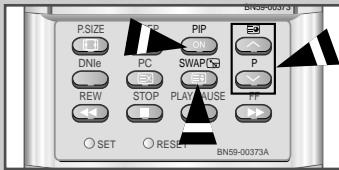
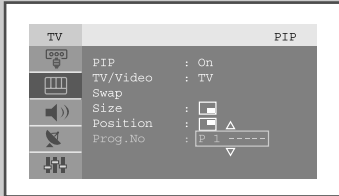
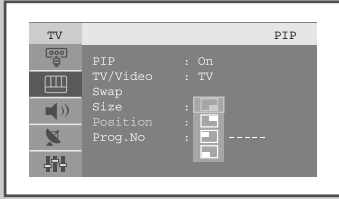

- 9 Press the ▲ or ▼ button to select **Position** and then press the **ENTER** (↵) or ► button.
Select the position of sub picture by pressing the ▲ or ▼ button and then press the **ENTER** (↵) or ► button.

Result: You can move the sub picture counterclockwise.

➤ ◆ When the size of sub picture is set to **Double1** or **Double2**, this feature does not work.

- 10 Press the ▲ or ▼ button to select **Prog.No.**
You can select the channel that you want to view through sub picture by pressing the ▲ or ▼ button.

Result: The memorized **Prog.No** is displayed.

- 11 To return to normal viewing press the **EXIT** button.

➤ Remote-control functions while "PIP" is "On":

Features	Description
PIP ON	Used to operate ON/OFF function of PIP directly.
SWAP	Used to interchange the main picture and the sub picture. ➤ When the main picture is in the Video mode and the sub picture is in the set mode, you might not hear the sound of main picture when pressing the SWAP button after changing the sub picture channel. At this time, reselect the main picture channel.

⏏ Used to select the channel of sub picture.

➤ PIP Settings

Main \ Sub	TV	AV1	AV2	AV3	S-Video	COMP1	COMP2	PC/DVI
TV	0	0	0	0	0	0	0	X
AV1	0	X	0	0	0	X	X	X
AV2	0	0	X	0	0	0	0	X
AV3	0	0	0	X	0	0	0	X
S-Video	0	0	0	0	X	0	0	X
COMP1	0	X	0	0	0	X	X	X
COMP2	0	X	0	0	0	X	X	X
PC/DVI	0	0	0	0	0	0	0	X

Adjusting the Volume

You can adjust the volume using your remote control.

Press the **+** button to increase the volume.

Result: A horizontal bar is displayed and the volume increases until you release the button. The cursor moves to the right to indicate the volume.

Press the **-** button to decrease the volume.

Result: A horizontal bar is displayed and the volume decreases until you release the button. The cursor moves to the left to indicate the volume.

- Additional sound adjustments are available on your set. For further details, refer to pages **30** to **37**.



Switching the Sound Off Temporarily

You can switch the sound off temporarily.

Example: You wish to answer the telephone.

- 1 Press the **MUTE** (🔇) button.

Result: The sound is switched off and "Mute" is displayed.

- 2 When you wish to turn the sound back on, press the **MUTE** (🔇) button again or either of the volume buttons.

Result: The sound comes back on at the same volume as before and the "Mute" indication disappears.



Changing the Sound Standard

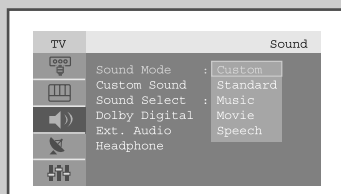
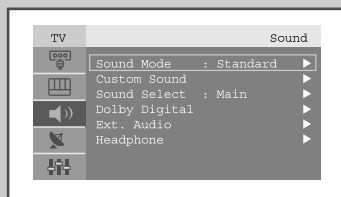

You can select the type of special sound effect to be used when watching a given broadcast.

- 1 Press the **MENU** button.
Result: The main menu is displayed.
- 2 Press the **▲** or **▼** button to select **Sound**.
Result: The options available in the **Sound** group are displayed.
- 3 Press the **ENTER** or **▶** button.
- 4 Press the **ENTER** or **▶** button again.
Result: The **Sound Mode** is selected.
- 5 Select the required sound effect by pressing the **▲** or **▼** button repeatedly and then press the **ENTER** or **▶** button.
The following sound effects are available:

Custom - Standard - Music - Movie - Speech

➤ You can also select these options by simply pressing the **S.MODE** (Sound Mode) button on the remote control.

Adjusting the Sound Settings

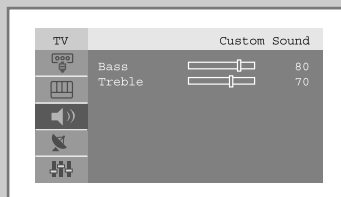
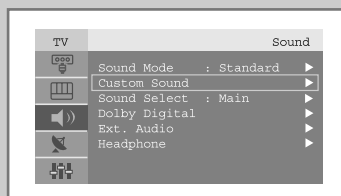

The sound settings can be adjusted to suit your personal preferences.

- 1 Press the **MENU** button.
Result: The main menu is displayed.
- 2 Press the **▲** or **▼** button to select **Sound**.
Result: The options available in the **Sound** group are displayed.
- 3 Press the **ENTER** or **▶** button.
- 4 Select **Custom Sound** by pressing the **▲** or **▼** button and then press the **ENTER** or **▶** button.
Result: **Bass** and **Treble** are displayed.
- 5 Select the option (**Bass** or **Treble**) to be adjusted by pressing the **▲** or **▼** button. Press the **ENTER** or **▶** button.
Result: The horizontal bar is displayed.
- 6 Press the **◀** or **▶** button to reach the required setting and then press the **ENTER** button.
- 7 When you are satisfied with the setting, press the **MENU** button to return to the previous menu or press the **EXIT** button to return to normal viewing.

Listening to the Sound of the Sub Picture

During the PIP feature is activating, you can listen to the sound of the sub picture.

- 1 Press the **MENU** button.

Result: The main menu is displayed.

- 2 Press the **▲** or **▼** button to select **Sound**.

Result: The options available in the **Sound** group are displayed.

- 3 Press the **ENTER**  or **▶** button.

- 4 Press the **▲** or **▼** button to select **Sound Select** and then press the **ENTER**  or **▶** button.

Result: **Main** and **Sub** are displayed.

➤ When the PIP option only be "On", you can select these option.

- 5 Select the **sub** by pressing the **▲** or **▼** button.
Press the **ENTER**  or **▶** button.

Result: You can listen to the sound of the sub picture.

➤ To listen the sound of current main picture, set to **Main**.

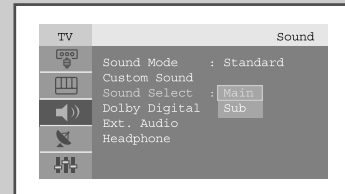
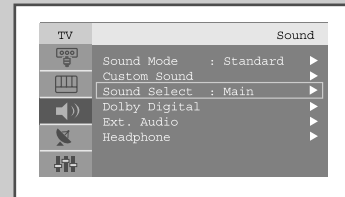

Setting the Dolby Digital Surround

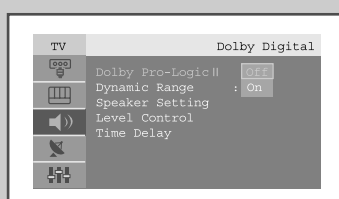
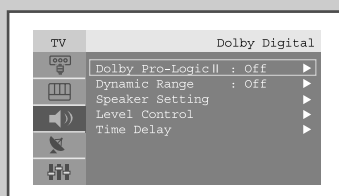
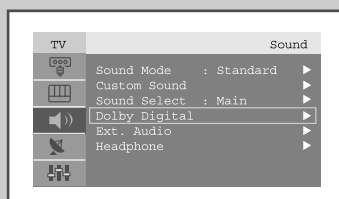

Dolby Pro-Logic II On

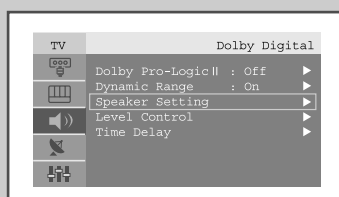
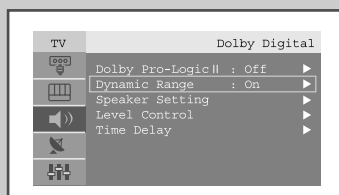







The following Dolby surround settings can be adjusted to suit your personal preferences.

- ◆ **Dolby Pro-Logic II On/Off.**
- ◆ **Dynamic range for adjusting the volume Dolby Pro-Logic II On/Off during night time viewing.**
- ◆ **Speaker setting for Dolby Digital surround.**
- ◆ **Activation/Deactivation of test tone to simulate the volume on each speaker.**
- ◆ **Volume level control of the each speaker.**
- ◆ **Delay time for the rear speakers (0~15ms).**

- 1 Press the **MENU** button.
Result: The main menu is displayed.
- 2 Press the **▲** or **▼** button to select **Sound**.
Result: The options available in the **sound** group are displayed.
- 3 Press the **ENTER** or **▶** button.
- 4 Press the **▲** or **▼** button to select **Dolby Digital**. Press the **ENTER** or **▶** button.
Result: The option available in the **Dolby Digital** group are displayed with **Dolby Pro-Logic II** selected.
- 5 Press the **ENTER** or **▶** button.
- 6 Select the option (**On** or **Off**) by pressing the **▲** or **▼** button. Press the **ENTER** or **▶** button.
 - You can also select these option(Dolby Pro-Logic II On/Off) by simply pressing the **SURROUND** button on the remote control.
 - For further details of output depending on each option, refer to **34** page.
- 7 Press the **▲** or **▼** button to select **Dynamic Range**. Press the **ENTER** or **▶** button.
If you wish to adjust the volume for nighttime viewing, select **Off** by pressing the **▲** or **▼** button.
- 8 Press the **ENTER** or **▶** button.
- 9 Press the **▲** or **▼** button to select **Speaker Setting**. Press the **ENTER** or **▶** button.
Result: The options available in the **Speaker Setting** group are displayed with front left selected.
- 10 Select the speaker (**Front Left, Center, Front Right, Rear Right, Rear Left, Sub Woofer**) to be adjusted by pressing the **▲** or **▼** button. Press the **ENTER** or **▶** button.



- When 'Front Left/Right' is set to 'Large' on the Speaker Setting menu, the sub woofer is automatically turned off.
If the sub woofer is switched on, 'Front Left/Right' is automatically set to 'Small'.

Setting the Dolby Digital Surround (continued)

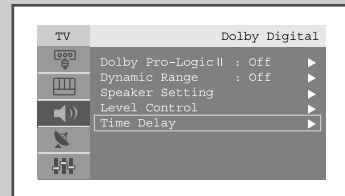
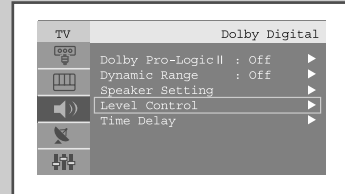
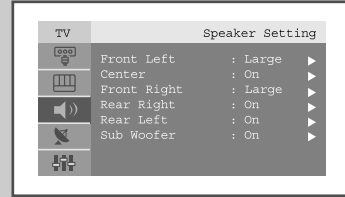
- 11 Select the speaker size(**Front Left, Front Right:Small/Large**) and select **On** or **Off(Center, Rear Right, Rear Left and Sub Woofer)** by pressing the **▲** or **▼** button.
Press the **ENTER**  or **▶** button.
- 12 Press the **MENU** or **◀** button to return to the previous menu.
- 13 Press the **▲** or **▼** button to select **Level Control**.
Press the **ENTER**  or **▶** button.
Result: The option available in the **Level Control** group are displayed with **Test Tone** selected.
- 14 Select **Test Tone(On/Off)** by pressing the **▲** or **▼** button.
Press the **ENTER**  or **▶** button.
- 15 Select the speaker (**Front Left, Center, Front Right, Rear Right, Rear Left, or Sub Woofer**) by pressing the **▲** or **▼** button and adjust **Level Control** (-10dB~10dB) by pressing the **◀** or **▶** button.
Press the **ENTER**  or **▶** button.
- 16 Press the **MENU** or **◀** button to return to the previous menu.
- 17 Press the **▲** or **▼** button to select **Time Delay**.
Press the **ENTER**  or **▶** button.
Result: The options available in the **Time Delay** group are displayed.
- 18 Select the speaker (**Rear Left and Rear Right**) by pressing the **▲** or **▼** button.
Adjust the **Time Delay** (0~15ms) of the surround channel by pressing the **◀** or **▶** button.
Press the **ENTER**  button.
- 19 When you are satisfied with the setting, press the **MENU** button to return to the previous menu or press the **EXIT** button to return to normal viewing.



➤ TRADEMARKS & LABELS

Sound Mode	Trademark on Product	License Notice
DTS Digital Surround (DTS 5.1 decoding inside)		Manufactured under license from Digital Theater System, Inc. US Pat. No. 5,451,942, 5,956,674, 5,974,380, 5,978,762 and other world-wide patents issued and pending. "DTS" and "DTS Digital Surround" are registered trademarks of Digital Theater System, Inc. Copyright 1996, 2000 Digital Theater Systems, Inc. All Rights Reserved.
Pro Logic II & Dolby Digital		Manufactured under license from Dolby Laboratories. "Dolby", "Pro Logic", and the double-D symbol are trademarks of Dolby Laboratories.

Setting the Dolby Pro Logic I

In case of "Pro Logic : On"

Input (Source) \ Output	Main Left	Center	Main Right	Surround		Sub Woofer
				Right	Left	
Mono		✓				
PCM Stereo (L/R)	✓	✓	✓	✓	✓	
Dolby Digital	Mono		✓			
	Lo/Ro	✓	✓	✓	✓	
	Lt/Rt	✓	✓	✓	✓	✓
	5.1ch	✓	✓	✓	✓	✓
DTS	✓	✓	✓	✓	✓	✓
MPEG I (Stereo only)	✓	✓	✓	✓	✓	
MPEG II	✓	✓	✓	✓	✓	✓



In case of "Pro Logic : Off"

Input (Source) \ Output	Main Left	Center	Main Right	Surround		Sub Woofer
				Right	Left	
Mono	✓		✓			
PCM Stereo (L/R)	✓		✓			
Dolby Digital	Mono	✓	✓			
	Lo/Ro	✓		✓		
	Lt/Rt	✓		✓		
	5.1ch	✓	✓	✓	✓	✓
DTS	✓	✓	✓	✓	✓	✓
MPEG I (Stereo only)	✓		✓			
MPEG II	✓	✓	✓	✓	✓	✓

➤ The output of Sub Woofer is changed depending on the speaker setting.

Setting the External Digital Sound

You can enjoy Digital sound when the equipment with Digital output is connected to the television.

- 1 Press the **MENU** button.
Result: The main menu is displayed.
- 2 Press the **▲** or **▼** button to select **Sound**.
Result: The options available in the **Sound** group are displayed.
- 3 Press the **ENTER**  or **▶** button.
- 4 Press the **▲** or **▼** button to select **Ext. Audio**.
Press the **ENTER**  or **▶** button.
Result: The **Ext. Audio** menu are displayed.
- 5 Select the required output (**Optical**, **Coaxial**) by pressing the **▲** or **▼** button.
- 6 Press the **ENTER**  or **▶** button.
Result: **Off - AV1 - AV2 - AV3 - S-Video - Comp1 - Comp2 - PC/DVI** are displayed
Select the option (**Off - AV1 - AV2 - AV3 - S-Video - Comp1 - Comp2 - PC/DVI**) by pressing the **▲** or **▼** button.
- 7 When you are satisfied with your choice, press the **MENU** button to return to the previous menu or press the **EXIT** button to return to normal viewing.

- **Optical cable:** Changes electric pulses into optical signals for transmission. This transmission system transmits the digital audio signals in the S/PDIF format, in which the glass conductor transmits the signals in the form of light.
- **Coaxial cable:** Uses copper wires to transmit the digital signals.

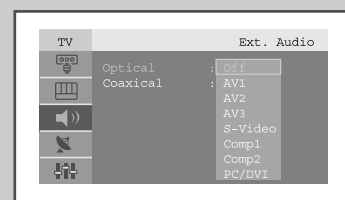
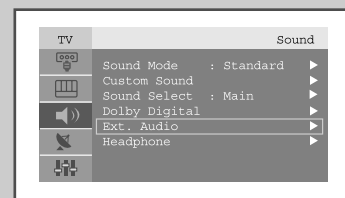
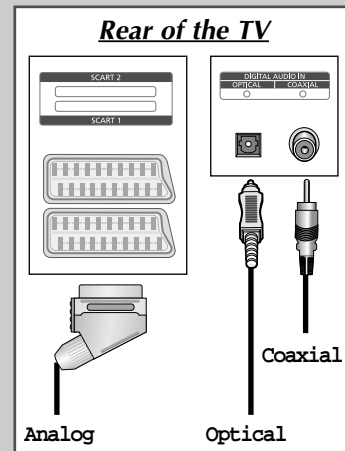

Connecting Headphones

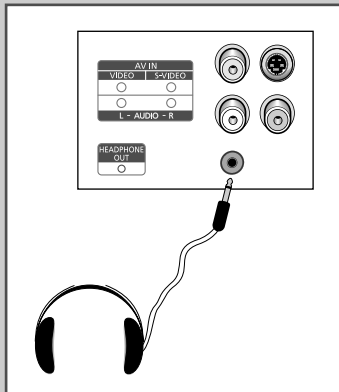

You can connect a set of headphones to your set if you wish to watch a TV programme without disturbing the other people in the room.

Plug a set of headphones into the 3.5mm mini-jack socket on the panel of the set.

Result: The sound is heard through the headphones.

➤ For further details on how to set your headphone preferences, refer to the section below.

- Prolonged use of headphones at a high volume may damage your hearing.
- You will not receive sound from the speakers when you connect headphones to the system.

Adjusting Your Headphone Preferences

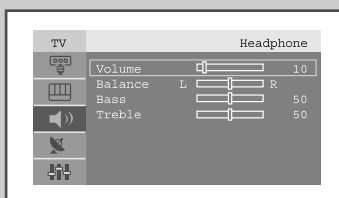

You can adjust the headphone settings to suit your preferences.

The following headphones settings are available:

◆ **Volume, Balance, Bass, Treble.**

- 1 Press the **MENU** button.
Result: The main menu is displayed.
- 2 Press the **▲** or **▼** button to select **Sound**.
Result: The options available in the **sound** group are displayed.
- 3 Press the **ENTER** (↵) or **▶** button.
- 4 Press the **▲** or **▼** button to select **Headphone**. Press the **ENTER** (↵) or **▶** button.
Result: The **Headphone** sound menu (**Volume**, **Balance**, **Bass**, **Treble**) is displayed.

To...	Then...
Change the option	Press the ▲ or ▼ button.
Change a setting	Press the ◀ or ▶ button.
Confirm the changes	Press the ENTER (↵) button.

Selecting the Sound Mode

The "DUAL I-II" button displays/controls the processing and output of the audio signal. When power is switched on, the mode is automatically preset to either "Dual-I" or "Stereo", depending on the current transmission.

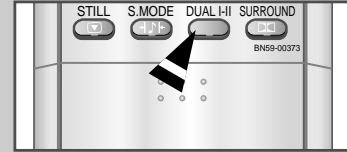

	Type of broadcast	On-screen indication
NICAM Stereo	Regular broadcast (Standard audio)	MONO (Normal use)
	Regular + NICAM Mono	MONO ↔ MONO NICAM (Normal)
	NICAM Stereo	STEREO ↔ MONO NICAM (Normal)
	NICAM Dual-I/II	Dual-I → Dual-II → MONO NICAM NICAM (Normal) ↑—————↑
A2 Stereo	Regular broadcast (Standard audio)	MONO (Normal use)
	Bilingual or Dual-I/II	DUAL-I ↔ DUAL-II
	Stereo	STEREO ↔ MONO (Forced mono)

- ◆ If the receiving conditions deteriorate, listening will be easier if the mode is set to the **MONO**.
- ◆ If the stereo signal is weak and an automatic switching occurs, then switch to the **MONO**.
- ◆ When receiving a mono sound in the AV mode, connect to the "AUDIO (L)" input connector on the rear panel.

Setting and Displaying the Current Time

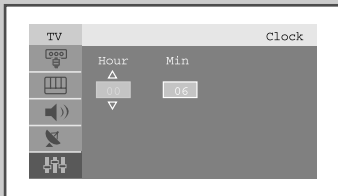
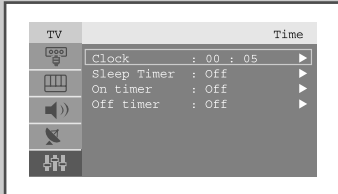
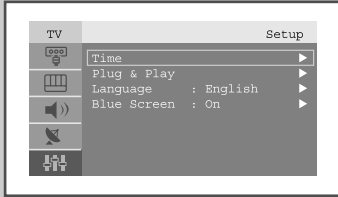

You can set the TV'S clock so that the current time is displayed when you press the "INFO" button. You must also set the time if you wish to use the automatic On/Off timers.

➤ If you disconnect the power cord or switch off the power on the front panel, you have to set the clock again.

1 Press the **MENU** button.

Result: The main menu is displayed.

2 Press the **▲** or **▼** button to select **Setup**.
Press the **ENTER** or **▶** button

Result: The options available in the **Setup** group are displayed with **Time** selected.

3 Press the **ENTER** or **▶** button.

Result: The **Time** menu are displayed with **clock** selected.

4 Press the **ENTER** or **▶** button.

5 To...	Press the...
Move to Hour or Min	◀ or ▶ button
Set the hour or minute	▲ or ▼ button

6 When you have satisfied with the setting, press the **MENU** button to return to the previous menu or press the **EXIT** button to return to normal viewing.

7 To display the...	Press the...
Current time and selected audio/video setting status	INFO button

Setting the Sleep Timer

You can select a time period of between 30 and 180 minutes after which the television automatically switches to standby mode.

- 1 Press the **MENU** button.
Result: The main menu is displayed.
- 2 Press the **▲** or **▼** button to select **Setup**.
Press the **ENTER** or **▶** button.
Result: The options available in the **Setup** group are displayed with **Time** selected.
- 3 Press the **ENTER** or **▶** button.
Result: The **Time** menu are displayed with **clock** selected.
- 4 Press the **▲** or **▼** button to select **sleep timer**.
Press the **ENTER** or **▶** button.
- 5 Press the **▲** or **▼** button repeatedly and cycle through the preset time intervals (30, 60, 90, 120, 150, 180).
Result: The TV automatically switches to standby mode when the timer reaches 0.
- 6 To cancel the sleep timer function, select **set** by pressing the **◀** or **▶** button and then select "OFF" by pressing the **▲** or **▼** button.

You can set the sleep timer by simply pressing the "SLEEP" button on the remote control.

- 1 Press the **SLEEP** button on the remote control.
Result: If the sleep timer is not yet set, **OFF** is displayed. Otherwise, the remaining time before which the television switches to Standby mode is displayed.
- 2 Select the preset time interval for staying on by pressing the **SLEEP** button repeatedly.

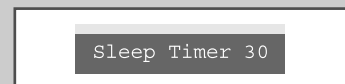
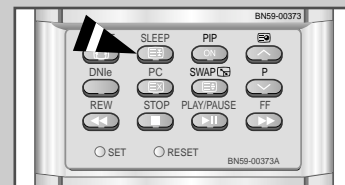
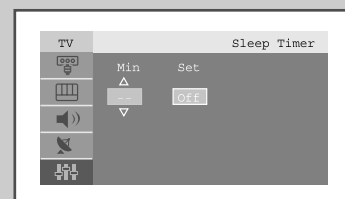
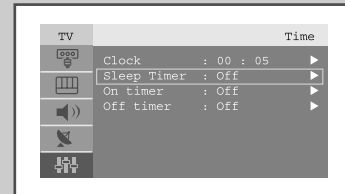
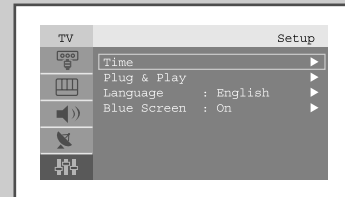

Switching the Television On and Off Automatically

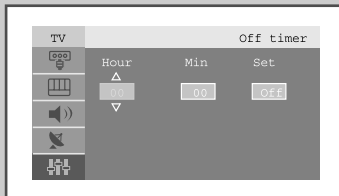
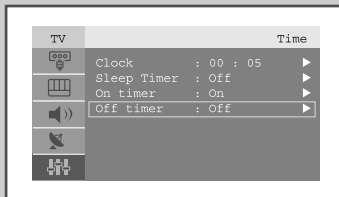
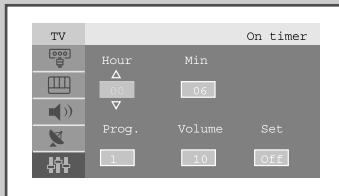
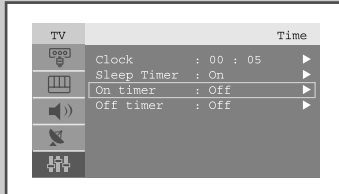
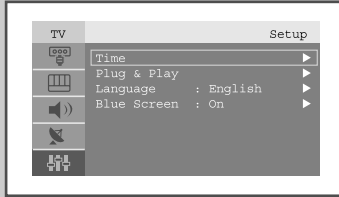

English-40

You can set the On/Off timers so that the set will :

- ◆ Switch on automatically and tune to the channel of your choice at the time you select.
- ◆ Switch off automatically at the time you select.

➤ The first step is to set the television's clock (refer to "Setting and Displaying the Current Time" on page 38).

- 1 Press the **MENU** button.
Result: The main menu is displayed.

- 2 Press the **▲** or **▼** button to select **Setup**.
Press the **ENTER** (↵) or **▶** button
Result: The options available in the **Setup** group are displayed with **Time** selected.

- 3 Press the **ENTER** (↵) or **▶** button.
Result: The **Time** menu are displayed with **clock** selected.

- 4 Press the **▲** or **▼** button to select **On timer**.
Press the **ENTER** (↵) or **▶** button.
Result: The **On Time** menu are displayed.

- 5 Set the time, channel and volume level at which you wish the set to be switched on.

To...	Press the...
Move to Hour , Min , Prog , and Volume	◀ or ▶ button
Set Hour, Minute, Prog.No, and Volume level	▲ or ▼ button
Move to Set	◀ or ▶ button
Select On to enable above setting	▲ or ▼ button

- 6 Press the **▲** or **▼** button to select **Off timer**.
In the same way, set the time at which you wish the set to be switched off automatically.

- 7 **To display the...**

To display the...	Press the...
Current time and selected audio/video setting status	INFO button

Setting the Blue Screen Mode

If no signal is being received or the signal is very weak, a blue screen automatically replaces the noisy picture background.

If you wish to continue viewing the poor picture, you must set the "Blue screen" mode to "Off".

- 1 Press the **MENU** button.

Result: The main menu is displayed.

- 2 Press the **▲** or **▼** button to select **Setup**.
Press the **ENTER**  or **▶** button.

Result: The options available in the **Setup** group are displayed.

- 3 Press the **▲** or **▼** button to select **Blue Screen**.
Press the **ENTER**  or **▶** button.

- 4 Select the required option (**On** or **Off**) by pressing the **▲** or **▼** button.

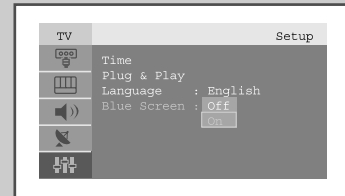
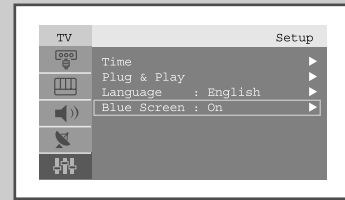

- 5 Press the **EXIT** button to return to normal viewing.

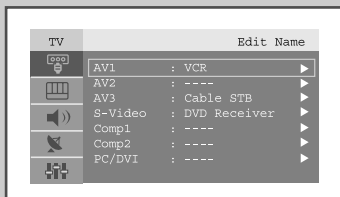
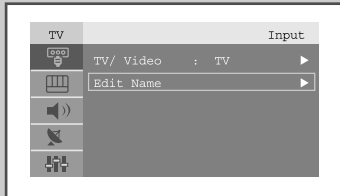
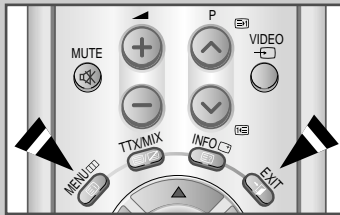

Selecting a Device from External Sources



Your set enables you to choose which audio/video signals are output to the external connector.

- 1 Press the **MENU** button.
Press the **ENTER**  or **▶** button to select **Input**.
Result: The options available in the **Input** group are displayed.
- 2 Press the **▲** or **▼** button to select **Edit Name**.
Press the **ENTER**  or **▶** button.
Result: The options available in the **Edit Name** menu are displayed.
- 3 Select the device that you wish to edit by pressing the **▲** or **▼** button.
The following options are available:
AV1 - AV2 - AV3 - S-Video - Comp1 - Comp2 - PC/DVI
- 4 Press the **ENTER**  or **▶** button.
- 5 Select the required device by pressing the **▲** or **▼** button repeatedly.
The following options are available:
VCR - DVD - Cable STB - HD STB - Satellite STB - AV Receiver - DVD Receiver - Game - Camcorder - DVD Combo - DVD HDD Recorder - PC
- 6 When you are satisfied with the setting, press the **MENU** button to return to the previous menu or press the **EXIT** button to return to normal viewing.

Viewing Pictures from External Sources

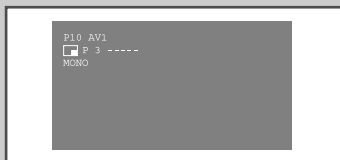

Once you have connected up your various audio and video systems, you can view the different sources by selecting the appropriate input.

- 1 Check that all the necessary connections have been made.
- 2 Press the **VIDEO** button.
Result: The edited device and audio status are displayed on Top-left of the set.
- 3 Press the **VIDEO** button until the required input source is selected.
➤ If you change the external source while viewing, pictures might take a short period of time to be switched.

Setting up Your PC Software (Based on Windows 2000 or XP)

The Windows display-settings for a typical computer are shown below. But the actual screens on your PC will probably be different, depending upon your particular version of Windows and your particular video card. But even if your actual screens look different, the same, basic set-up information will apply in almost all cases. (If not, contact your computer manufacturer or Samsung Dealer.)

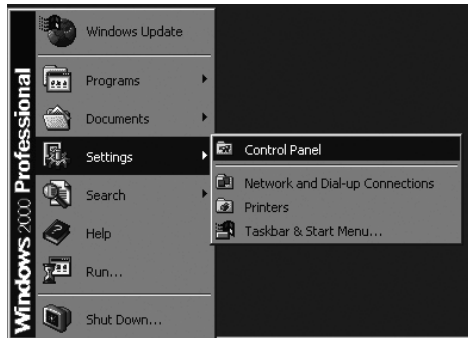

- 1 First, click on **"Settings"** on the Windows start menu. While **"Settings"** is highlighted, move the cursor so that **"Control Panel"** is highlighted.

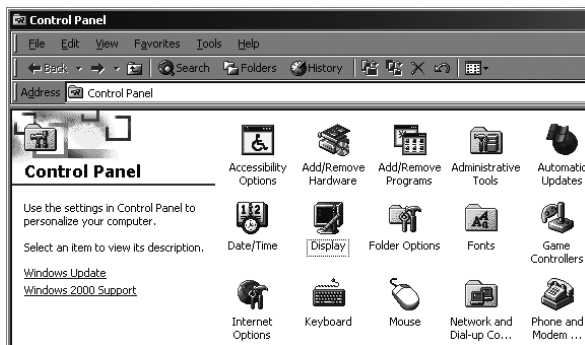

- 2 When the control panel screen appears, click on **"Display"** and a display dialog-box will appear.

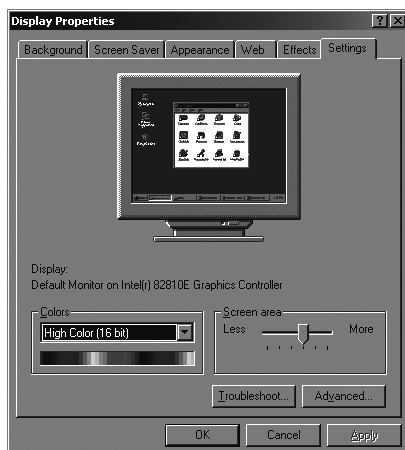

- 3 Navigate to the **"Settings"** tab on the display dialog-box.

The correct setting of size (resolution)
- **1280 x 768 pixels**

If a vertical-frequency option exists on your display settings dialog box, the correct value is **"60"** or **"60 Hz"**. Otherwise, just click **"OK"** and exit the dialog box. (Refer to 'Display Mode' on page 57)

Adjusting the PC Screen Automatically

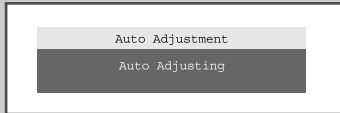
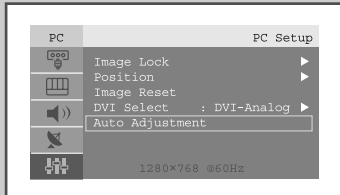
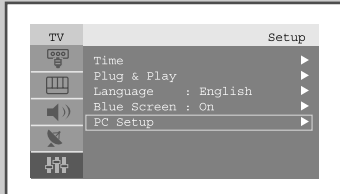
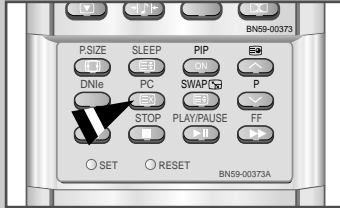

*Auto adjustment allows the PC screen of set to self-adjust to the incoming PC video signal.
The values of fine, coarse and position are adjusted automatically.*

- Press the **PC** button on the remote control to select the PC mode.
- This function does not work in **DVI-Digital** mode.

- 1 Press the **MENU** button.
Result: The main menu is displayed.

- 2 Press the **▲** or **▼** button to select **Setup**.
Press **ENTER** (↵) or **▶** button.
Result: The options available in the **Setup** group are displayed.

- 3 Press the **▲** or **▼** button to select **PC Setup**.
Press the **ENTER** (↵) or **▶** button.
Result: The options available in the **PC Setup** menu are displayed.

- 4 Press the **▲** or **▼** button to select **Auto Adjustment**.
Press the **ENTER** (↵) or **▶** button.
Result: After the PC screen twists during the auto adjustment procedure, the screen quality and position are automatically adjusted.

Coarse and Fine Tuning of the Image

The purpose of picture quality adjustment is to remove or reduce picture noise.

If the noise is not removed by Fine tuning alone, then adjust the frequency as best as possible (coarse) and Fine tune again.

After the noise has been reduced, re-adjust the picture so that it is aligned on the center of screen.

- Press the **PC** button on the remote control to select the PC mode.
- This function does not work in **DVI-Digital** mode.

- 1 Press the **MENU** button.
Result: The main menu is displayed.
- 2 Press the **▲** or **▼** button to select **Setup**.
Press **ENTER** or **▶** button.
Result: The options available in the **setup** group are displayed.
- 3 Press the **▲** or **▼** button to select **PC Setup**.
Press the **ENTER** or **▶** button.
Result: The options available in the **PC Setup** menu are displayed.
- 4 Press the **ENTER** or **▶** button again.
Result: The **Image Lock** menu is selected.
- 5 Press the **▲** or **▼** button to select **Coarse** or **Fine**.
Press the **ENTER** or **▶** button.
Result: The horizontal bar is displayed.
- 6 Press the **◀** or **▶** button to adjust the screen quality.
Vertical stripes may appear or the picture may become blurry.
- 7 When you are satisfied with the settings, press the **MENU** button to return to the previous menu or press the **EXIT** button to return to normal viewing.

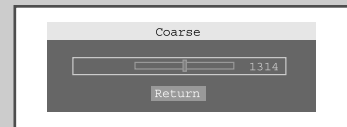
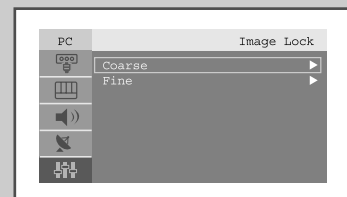
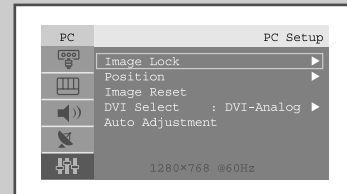
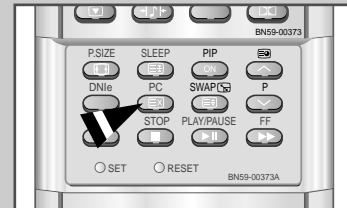

Changing the Image Position

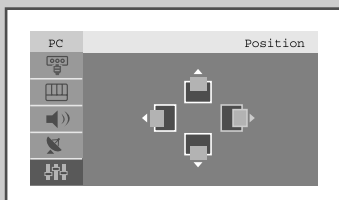
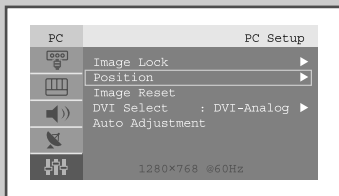
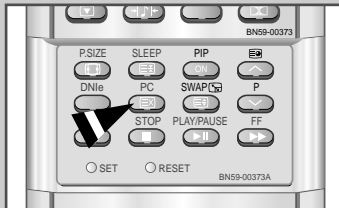

- Press the **PC** button on the remote control to select the PC mode.
- This function does not work in **DVI-Digital** mode.

- 1 Press the **MENU** button.
Result: The main menu is displayed.
- 2 Press the **▲** or **▼** button to select **Setup**.
Press the **ENTER** (↵) or **▶** button.
- 3 Press the **▲** or **▼** button to select **PC Setup**.
Press the **ENTER** (↵) or **▶** button.
Result: The options available in the **PC Setup** menu are displayed.
- 4 Press the **▲** or **▼** button to select **Position**.
Press the **ENTER** (↵) or **▶** button.
Result: You can adjust the image **Position**.
- 5 Press the **◀** or **▶** button to adjust horizontal position.
Press the **▲** or **▼** button to adjust vertical position.
- 6 Press **MENU** button to return to the previous menu or press the **EXIT** button to return to normal viewing.

Initializing the Image Settings

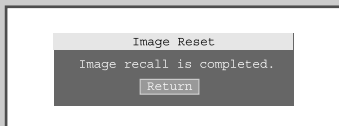
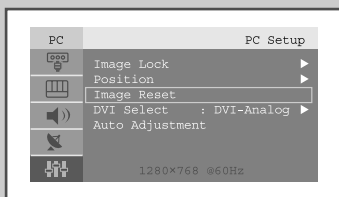
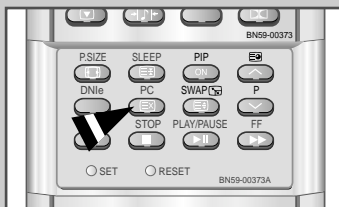

You can replace all image settings with the factory default values.

- Press the **PC** button on the remote control to select the PC mode.
- This function does not work in **DVI-Digital** mode.

- 1 Press the **MENU** button.
Result: The main menu is displayed.
- 2 Press the **▲** or **▼** button to select **Setup**.
Press the **ENTER** (↵) or **▶** button.
- 3 Press the **▲** or **▼** button to select **PC Setup**.
Press the **ENTER** (↵) or **▶** button.
Result: The options available in the **PC Setup** menu are displayed.
- 4 Press the **▲** or **▼** button to select **Image Reset**.
Press the **ENTER** (↵) or **▶** button.
Result: You can initialize all image settings (Image Lock, Position) to the factory default values.

Selecting the DVI mode

You can select the DVI mode(DVI-Analog or DVI-Digital)according to the pc input source(video board, video card or graphics card)

➤ Press the **PC** button on the remote control to select the PC mode.

- 1 Press the **MENU** button.

Result: The main menu is displayed.

- 2 Press the **▲** or **▼** button to select **Setup**.
Press the **ENTER** or **▶** button.

- 3 Press the **▲** or **▼** button to select **PC Setup**.
Press the **ENTER** or **▶** button.

Result: The options available in the **PC Setup** menu are displayed.

- 4 Press the **▲** or **▼** button to select **DVI Select**.
Press the **ENTER** or **▶** button.

- 5 Press the **▲** or **▼** button to select **DVI-Analog** or **DVI-Digital**.

- 6 Press **MENU** button to return to the previous menu or press the **EXIT** button to return to normal viewing.

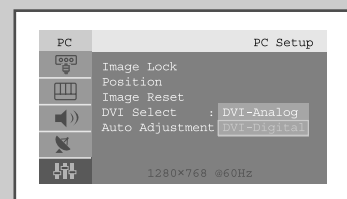
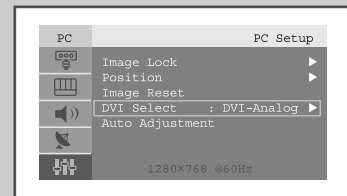
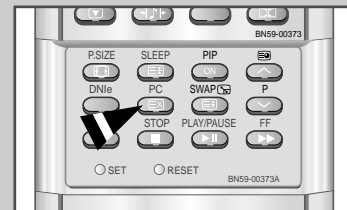

Teletext Decoder

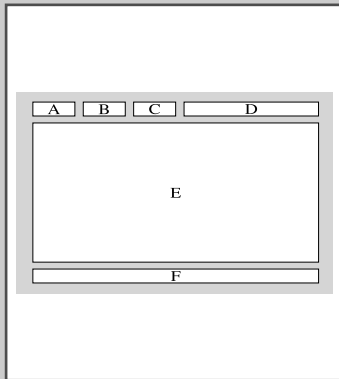

Most set channels carry "teletext", pages of written information that provide information such as:

- ◆ Television programme times
- ◆ News bulletins and Weather forecasts
- ◆ Sports results
- ◆ Subtitles for the hard of hearing

The teletext pages are organized according to six categories:

Part	Contents
A	Selected page number.
B	Broadcasting station identity.
C	Current page number or search status.
D	Date and time.
E	Text.
F	Status information.

Displaying the Teletext Information



You can display teletext information at any time, but signal reception must be good. Otherwise:

- ◆ Information may be missing
- ◆ Some pages may not be displayed

To activate the teletext mode and display the contents page:

- 1 Using the **P** (▲) or **P** (▼) button, select the channel providing the teletext service.
- 2 Press the **TTX/MIX** (⊞/⊠) button to activate the teletext mode.
Result: The contents page is displayed. It can be redisplayed at any time by pressing the **INDEX** (⊞) button.
- 3 To display the actual broadcast simultaneously with the teletext page, press the **TTX/MIX** (⊞/⊠) button.
- 4 To return to normal viewing, press the **CANCEL** (⊞x) button.
- 5 Press the **TTX/MIX** (⊞/⊠) button again to exit from the TTX display.

➤ If any broken character appears while TTX is being viewed, make sure that the TTX language is identical with the language in the "Setup" menu mode. If both languages are different, select the same language with the TTX language on the "Setup" menu.

Selecting a Specific Teletext Page

Press the number buttons on the remote control to enter the page number directly:

- 1 Enter the three-digit page number listed in the contents by pressing the corresponding numeric buttons.

Result: The current page counter is incremented and the page is then displayed.

- 2 If the selected page is linked with several secondary pages, the secondary pages are displayed in sequence. To freeze the display on a given page, press the **HOLD** (⏸) button. Press the **HOLD** (⏸) button again to resume.

- 3 Using the various display options:

To display...	Press the...
◆ Both teletext information and the normal broadcast	TTX/MIX (⏸/⏹)
◆ Hidden text (answers to quiz games, for example)	REVEAL (⏸)
◆ The normal screen	REVEAL (⏸) again
◆ A secondary page, by entering its 4-digit number	SUB-PAGE (⏸)
◆ The next page	PAGE UP (⏸)
◆ The previous page	PAGE DOWN (⏸)
◆ Double-size letters in the: <ul style="list-style-type: none"> • Upper half of the screen • Lower half of the screen 	SIZE (⏸) <ul style="list-style-type: none"> ◆ Once ◆ Twice
◆ Normal screen	◆ Three times

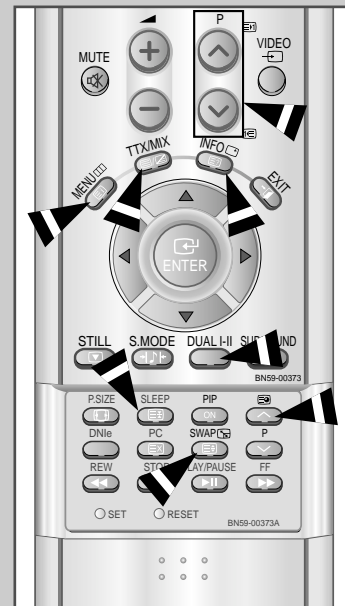

Using FLOF to Select a Teletext Page

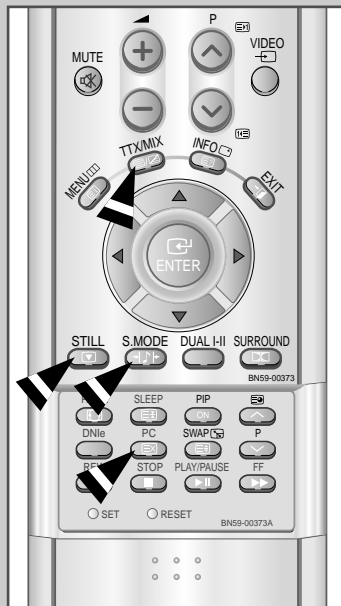

The various topics included in the teletext pages are color-coded, and can be selected by pressing the colored buttons on the remote control.

- 1 Display the teletext contents page by pressing the **TTX/MIX** (≡/☒) button.
- 2 Press the colored button corresponding to the topic that you wish to select (The available topics are listed on the status information line).

Result: The page is displayed with additional color-coded information that can be selected in the same way.



- 3

To display the:	Press the:
Previous page	Red button.
Next page	Green button.
- 4 When you have finished, press the **CANCEL** (☒) button to return to the normal broadcast.

Troubleshooting: Before Contacting Service Personnel

Before contacting Samsung after-sales service, perform the following simple checks.

If you cannot solve the problem using the instructions below, note the model and serial number of your set and contact your local dealer.

No sound or picture	<ul style="list-style-type: none"> ◆ Check that the mains lead has been connected to a wall socket. ◆ Check that you have pressed the POWER () button on the front of the TV. ◆ Check the picture contrast and brightness settings. ◆ Check the volume.
Normal picture but no sound	<ul style="list-style-type: none"> ◆ Check the volume. ◆ Check whether the MUTE () button has been pressed on the remote control.
No picture or black and white picture	<ul style="list-style-type: none"> ◆ Adjust the colour settings. ◆ Check that the broadcast system selected is correct.
Sound and picture interference	<ul style="list-style-type: none"> ◆ Try to identify the electrical appliance that is affecting the set and move it further away. ◆ Plug your set into a different mains socket.
Blurred or snowy picture, distorted sound	<ul style="list-style-type: none"> ◆ Check the direction, location and connections of your aerial. This interference is often due to the use of an indoor aerial.
Remote control malfunctions	<ul style="list-style-type: none"> ◆ Replace the remote control batteries. ◆ Clean the upper edge of the remote control (transmission window). ◆ Check the battery terminals.
"Check Signal Cable!" message is displayed.	<ul style="list-style-type: none"> ◆ Check that the signal cable is firmly connected to the PC or video sources. ◆ Check that the PC or video sources are turned on.
On PC mode, "Not Supported Mode" message is displayed.	<ul style="list-style-type: none"> ◆ Check the maximum resolution and the frequency of the video adapter. ◆ Compare these values with the data in the Display Modes Timing Chart.
The image is too light or too dark.	<ul style="list-style-type: none"> ◆ Adjust the Brightness and Contrast.
On PC mode, horizontal bars appear to flicker, jitter or shimmer on the image.	<ul style="list-style-type: none"> ◆ Adjust the Fine function.
On PC mode, vertical bars appear to flicker, jitter or shimmer on the image.	<ul style="list-style-type: none"> ◆ Adjust the Coarse function and then adjust the Fine function.
On PC mode, screen is black and power indicator light blinks every 1 seconds	<ul style="list-style-type: none"> ◆ The TV is using its power management system. ◆ Move the computer's mouse or press a key on the keyboard.
On PC mode, image is not stable and may appear to vibrate.	<ul style="list-style-type: none"> ◆ Check that the display resolution and frequency from your Computer or video board is an available mode for your set. On your Computer check: Control Panel, Display, Settings. ◆ If the setting is not correct, use your computer utility programme to change the display settings. <ul style="list-style-type: none"> ➤ Your set supports multiscan display functions within the following frequency domain: <ul style="list-style-type: none"> ◆ Horizontal frequency: 30 ~ 61 kHz ◆ Vertical frequency: 56 ~ 75 Hz ◆ Maximum refresh rate: 1280 X 768@60Hz
On PC mode, image is not centered on the screen.	<ul style="list-style-type: none"> ◆ Adjust the horizontal and vertical position.

Installing Stand

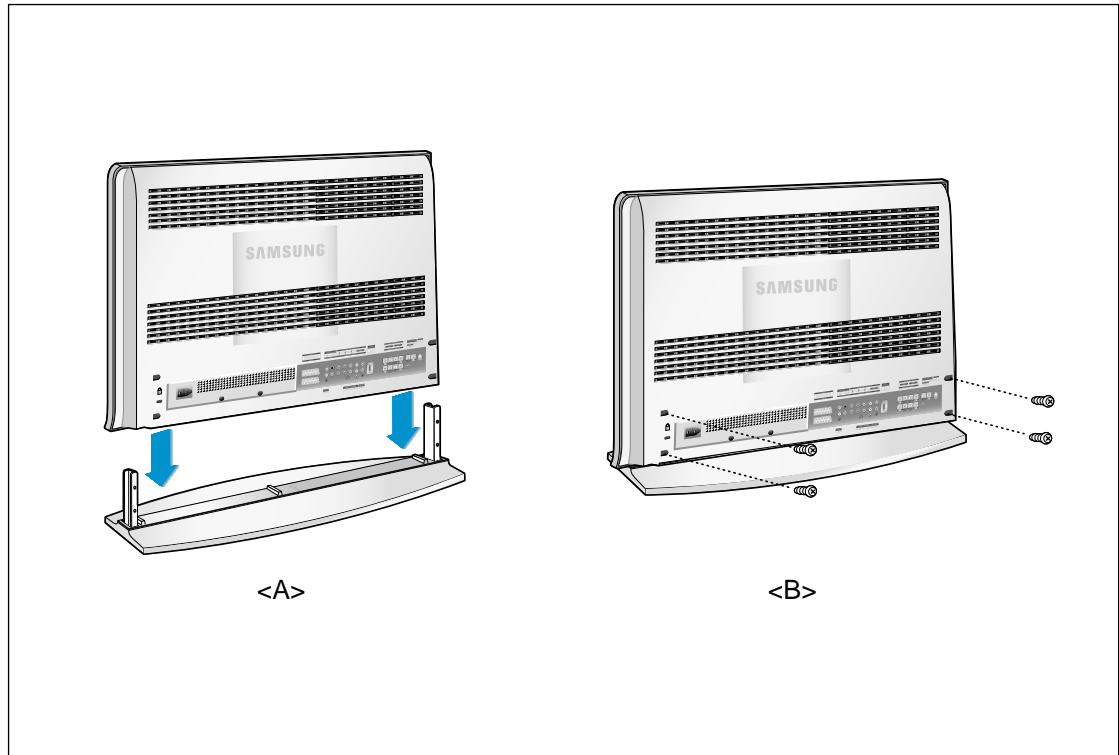

1. Lower the TV set in the direction of the arrow (at a right angle) and fix the stand.
2. Use the four screws to tightly fix the stand.

Maintenance of Your LCD TV

WARNING: To avoid risk of electric shock, do not disassemble the TV cabinet.

Users cannot service the TV. User maintenance is restricted to cleaning as explained below:

Unplug the LCD TV from the power outlet before cleaning.

- To clean your flat panel display screen, lightly dampen a soft, clean cloth with water or mild detergent. If possible, use a special screen cleaning tissue or solution suitable for the antistatic coating.
- To clean the LCD TV cabinet, use a cloth lightly dampened with a mild detergent.
- Never use flammable cleaning material to clean your LCD TV or any other electrical apparatus.

Using the Anti-Theft Kensington Lock

The Kensington lock is a device used to physically fix the system when using it in a public place. The locking device has to be purchased separately. The appearance and locking method may differ from the illustration depending on the manufacturer. Please refer to the manual provided with the Kensington lock for proper use.

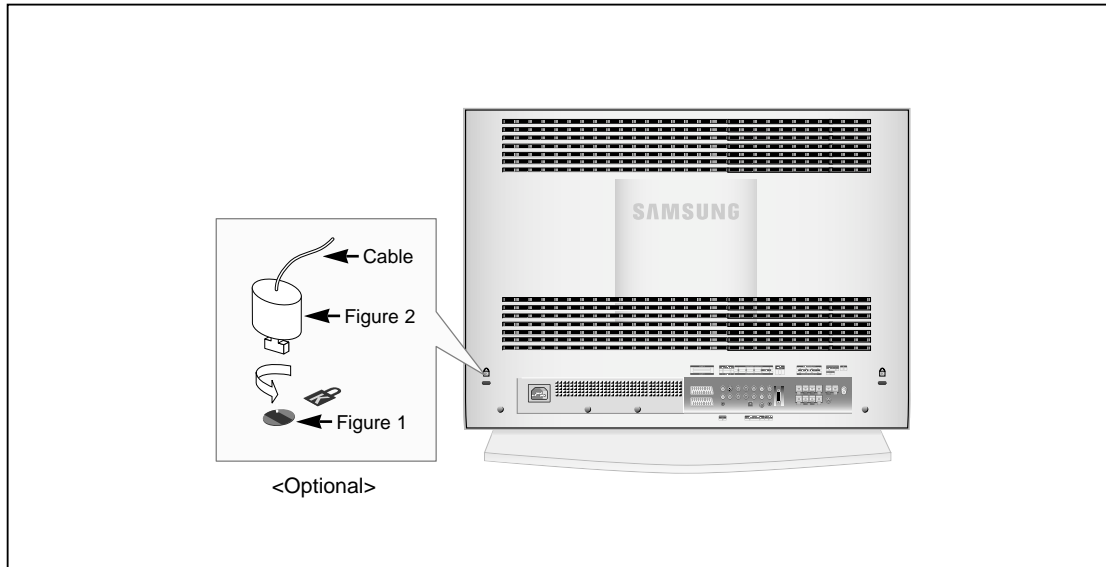

1. Insert the locking device into the Kensington slot on the LCD TV (figure 1), and turn it in the locking direction (figure 2).
2. Connect the Kensington lock cable.
3. Fix the Kensington lock to a desk or a heavy stationary object.

How to Install the Wall Bracket

List of Contents

Wall bracket

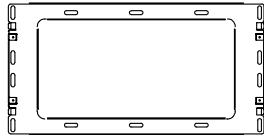

1 Wall bracket plate

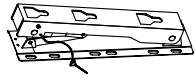

2 Assembly hinges
(Make sure they are a left/right pair.)

Main body bracket

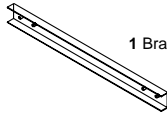

1 Bracket bar

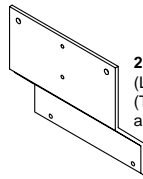

2 Brackets
(Left and Right)
(The two brackets are interchangeable.)

Screws



Plastic screw anchors: 4



Screws: 4



Screws: 8

How to Adjust the Angle of the Bracket

➤ Please adjust the angle of the bracket to 0 degrees before you fix it to the wall.

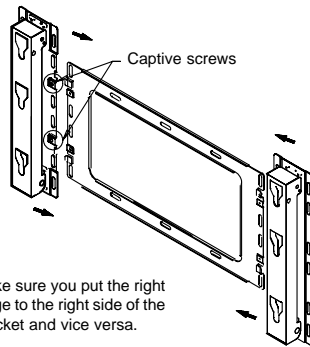

Make sure you put the right hinge to the right side of the bracket and vice versa.

Be aware of the correct installation direction of the bracket when you set the angle to 30 and 32 degrees. (The direction for 30 and 32 degrees is indicated on the bracket surface.) When you first open the box, the bracket is not assembled. Put the left and right brackets in the direction of the arrow and tighten the captive screws.

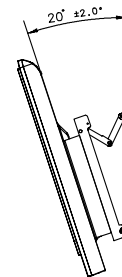
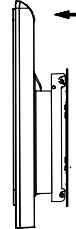

1. Attach the LCD TV onto the wall bracket. (Follow the instructions below.)
2. Pull the upper part of the LCD TV fixed to the bracket forward in the direction of the arrow and adjust the angle.
3. You can adjust the angle to your liking between 0°~20°(±2°).

How to Install the Wall Bracket

How to Attach the LCD TV to the Bracket

The LCD TV in the picture may not look exactly like yours.

(You assemble the plastic screw anchors and the screws the same way regardless of the model of your TV.)

- 1** Assemble the plastic screw anchors and the screws. (See the picture below.)



- 2** Assemble the main body bracket as below and put the plastic screw anchors in.

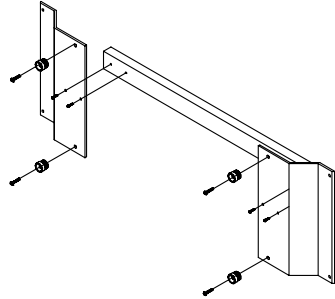

- 1) Attach the plastic screw anchors to each of the left/right brackets as in 1.
- 2) Assemble the bracket bars to the left/right brackets as in the picture on the left.

They are left-right and upper-lower symmetry and the assembly direction does not matter.

Warning

1. Installing a wall bracket must be done by a qualified professional installer.
2. After you hang the LCD TV on the wall bracket, check from both sides to see if the plastic screw anchors are securely in place.
3. Be careful not to get your fingers caught during installation or while adjusting the angle of the bracket.
4. The LCD TV may fall from the wall and hurt someone if the wall bracket is not attached securely to the wall. Make sure the bracket is screwed tightly to the wall.

- 3** Assemble the main body bracket as in the pictures in 2. and below.

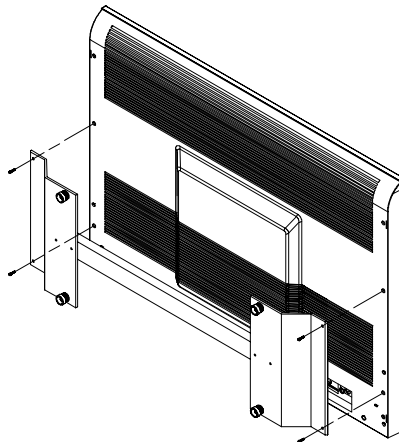

- 4** Put the four holders on the back of the TV into the holes on the wall bracket, (1) lower the TV, and (2) hang the TV on the bracket. Fasten the TV securely to the wall bracket with stickscrews as in (3) so that the two will not separate.

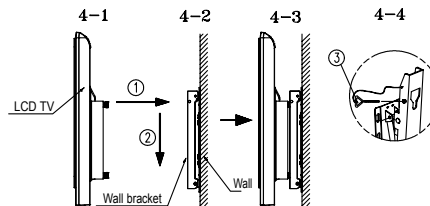

Technical and Environmental Specifications

Model Name	LW32A23W	LW40A23W
Panel		
Size	32" Diagonal	40" Diagonal
Display Size	687.36 (H) x 412.42 (V) mm	871.68 (H) x 523.008 (V) mm
Type	a-si TFT active matrix	
Pixel Pitch	0.537 (H) x 0.537 (V) mm	0.681 (H) x 0.681 (V) mm
Viewing Angle	170/170 (H/V)	
Frequency		
Horizontal	30 ~ 61 kHz	
Vertical	56 ~ 75 Hz	
Display Colour	16,777,216 colours	
Display Resolution		
Maximum Mode	1280 x 768 @ 60 Hz	
Input Signal		
Sync.	H/V Separate, TTL, P. or N.	
Video Signal	0.7 Vp-p @ 75 ohm	
TV		
Colour System	PAL/SECAM/NTSC 4.3	
Sound System	BG, DK, I, L	
Video		
Colour System	PAL/NTSC/SECAM	
Video System	CVBS, S-VHS, RGB	
Scart 1		
Video Input/Output	1.0 Vp-p @ 75 ohm	
RGB Input	0.7 Vp-p @ 75 ohm	
Audio Input/Output	500mVrms	
Scart 2		
Video Input/Output	1.0 Vp-p @ 75 ohm	
Audio Input/Output	500mVrms	
Component		
Video Input	1.0 Vp-p @ 75 ohm	
Audio Input	500mVrms	
Power Supply		
Input	AC 100 ~ 250 V (50/60Hz)	
Power Consumption		
Maximum	180 W	260 W
Power Saving	< 1.0 W	
Dimension (W x D x H)		
Body	801.0 x 218.0 x 625.0 mm	988.0 x 317.0 x 740.0 mm
With Speaker	1013.0 x 218.0 x 625.0 mm	1230.0 x 317.0 x 740.0 mm
Weight		
with stand	22 Kg	32 Kg

Technical and Environmental Specifications

Model	LW32A23W	LW40A23W
Environmental Considerations		
Operating Temperature	10 °C to 40 °C (50 °F to 104 °F)	
Operating Humidity	10% to 80%	
Storage Temperature	-25 °C to 45 °C (- 13 °F to 113 °F)	
Storage Humidity	5% to 95%	
Audio Characteristics		
Audio Input	RCA Jack (L, R), 0.5Vrms (-9dB)	
Audio Input (PC)	3.5 ϕ Stereo Jack, 0.5Vrms (-9dB)	
Headphone Output	Max. 10mW Output (3.5 ϕ Stereo Jack, 32 Ω)	
Frequency	RF: 80Hz ~ 15kHz (at- 3dB)	
Response	A/V: 80Hz ~ 20kHz (at- 3dB)	

Display Mode (PC/DVI)

*Both screen position and size will vary depending on the type of PC monitor and its resolution.
The table below shows all of the display modes that are supported:*

Mode	Resolution	Horizontal Frequency (kHz)	Vertical Frequency (Hz)	Pixel Clock Frequency (MHz)	Sync Polarity (H/V)
MAC	640 x 480	35.000	66.667	30.240	- / -
	832 x 624	49.726	74.551	49.500	+ / +
IBM	640 x 480	31.469	59.940	25.175	- / -
	720 x 400	31.469	70.087	28.322	- / +
VESA	640 x 480	37.861	72.809	31.500	- / -
	640 x 480	37.500	75.000	31.500	- / -
	800 x 600	37.879	60.317	40.000	+ / +
	800 x 600	48.077	72.188	50.000	+ / +
	800 x 600	46.875	75.000	49.500	+ / +
	1024 x 768	48.364	60.000	65.000	- / -
	1024 x 768	56.476	70.069	75.000	- / -
GTF	1024 x 768	60.023	75.029	78.750	+ / +
	1280 x 768	47.700	60.000	80.136	- / +

- ◆ The interlace mode is not supported.
- ◆ The set might operate abnormally if a non-standard video format is selected.
- ◆ The 4:3 mode does not work with input signals from "720 X 400".
- ◆ The DVI mode does not support "1024 X 768" (85Hz).

Pin Configurations

DVI connector

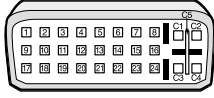

Pin	Description	Pin	Description
1	Rx 2-	16	Output Signal Connection
2	Rx 2+	17	Rx 0-
3	Grounding	18	Rx 0+
4	No connection	19	Grounding
5	No connection	20	No connection
6	DDC Clock (SCL)	21	No connection
7	DDC Data (SDA)	22	Grounding
8	Analog Vertical Sync	23	Rx C-
9	Rx 1-	24	Rx C+
10	Rx 1+	25(C3)	Analog (Blue)
11	Grounding	26(C5)	Analog Grounding
12	No connection	27(C4)	Analog Horizontal sync.
13	No connection	28(C2)	Analog (Green)
14	DDC Input Power (+5V)	29(C5)	Analog Grounding
15	Self-Raster	30(C1)	Analog (Red)

Wiring the Mains Power Supply Plug (UK Only)

◆ **IMPORTANT NOTICE**

The mains lead on this equipment is supplied with a moulded plug incorporating a fuse. The value of the fuse is indicated on the pin face of the plug and, if it requires replacing, a fuse approved to BS11362 of the same rating must be used. Never use the plug with the fuse cover omitted if the cover is detachable.

If a replacement fuse cover is required, it must be of the same colour as the pin face of the plug. Replacement covers are available from your dealer. If the fitted plug is not suitable for the power points in your house or the cable is not long enough to reach a power point, you should obtain a suitable safety approved extension lead or consult your dealer for assistance. However, if there is no alternative to cutting off the plug, remove the fuse and then safely dispose of the plug. Do NOT connect the plug to a mains socket as there is a risk of shock hazard from the bared flexible cord.

◆ **IMPORTANT**

The wires in the mains lead are coloured in accordance with the following code:

BLUE - NEUTRAL BROWN - LIVE

As these colours may not correspond to the coloured markings identifying the terminals in your plug, proceed as follows:

The wire coloured BLUE must be connected to the terminal marked with the letter N or coloured BLUE or BLACK. The wire coloured BROWN must be connected to the terminal marked with the letter L or coloured BROWN or RED.

WARNING: DO NOT CONNECT EITHER WIRE TO THE EARTH TERMINAL, WHICH IS MARKED WITH THE LETTER E OR BY THE EARTH SYMBOL \equiv , OR COLOURED GREEN OR GREEN AND YELLOW.

Setting Up Your Remote Control



After it has been set up properly, your remote control can operate in four different modes: TV, VCR, Cable, or DVD. Pressing the corresponding button on the remote control allows you to switch between these modes, and control whichever piece of equipment you choose.

Note

The remote control might not be compatible with all DVD Players, VCRs and Cable boxes.

Setting Up the Remote to Operate Your VCR

- 1 Turn off your VCR.
- 2 Press the **SELECT** button and make sure that the VCR LED is illuminated.
- 3 Press the **SET** button on your TV's remote control.
- 4 Using the number buttons on your remote control, enter three digits of the VCR code listed on page 63 of this manual for your brand of VCR. Make sure you enter three digits of the code, even if the first digit is a "0".
(If more than one code is listed, try the first one.)
- 5 Press the Power button on the remote control.
Your VCR should turn on if your remote is set up correctly.

If your VCR does not turn on after set up, repeat steps 2, 3, and 4, but try one of the other codes listed for your brand of VCR.
If no other codes are listed, try each VCR code, 000 through 089.

Note on Using Remote Control Modes: VCR

When your remote control is in "VCR" mode, the volume buttons still control your TV's volume.

Setting Up Your Remote Control

Setting Up the Remote to Operate Your Cable Box

- 1 Turn off your cable box.
- 2 Press the **SELECT** button and make sure that the Cable LED is illuminated.
- 3 Press the **SET** button on your TV's remote control.
- 4 Using the number buttons on your remote control, enter three digits of the cable box code listed on page 63 of this manual for your brand of cable box. Make sure you enter three digits of the code, even if the first digit is a "0".
If there is more than one code listed, try the first one.
- 5 Press the Power button on the remote control.
Your cable box should turn on if your remote is set up correctly.

If your cable box does not turn on after set up, repeat steps 2, 3, and 4, but try one of the other codes listed for your brand of cable box. If no other codes are listed, try each code, 000 through 077.

Note on Using Remote Control Modes: Cable Box
When your remote control is in "Cable Box" mode, the volume buttons still control your TV's volume.



Setting Up Your Remote Control



Setting Up the Remote to Operate Your DVD

- 1 Turn off your DVD.
- 2 Press the **SELECT** button and make sure that the DVD LED is illuminated.
- 3 Press the **SET** button on your TV's remote control.
- 4 Using the number buttons on your remote control, enter three digits of the DVD code listed on page 63 of this manual for your brand of DVD. Make sure you enter three digits of the code, even if the first digit is a "0".
If there is more than one code listed, try the first one.
- 5 Press the Power button on the remote control.
Your DVD should turn on if your remote is set up correctly.

If your DVD does not turn on after set up, repeat steps 2, 3, and 4, but try one of the other codes listed for your brand of DVD.
If no other codes are listed, try each code, 000 through 008.

Note on Using Remote Control Modes: DVD

When your remote control is in "DVD" mode, the volume buttons still control your TV's volume.

Setting Up Your Remote Control

Remote Control Codes

VCR Codes

Admiral	015,088	KLH	082	RCA	009,014,016,017,037,044,046,063,078
Aiwa	024	LG	001,002,007	Samsung	000,016,022,031,041,051
Audio Dynamics	022,025	Lloyd	024	Sansui	025
Bell&Howell	011	Logik	040	Sanyo	011,021
Broksonic	019	LXI	024	Scott	022,050,058,077
Candle	016,018,022,054,055,061	Magnavox	017,038,062,065	Sears	011,014,018,021,027,028,044,052,057
Canon	017,062	Marantz	011,017,023,025,038,039,055,070	Sharp	015,036,048,054
Citizen	016,018,022,054,055,061	Marta		Shintom	026,035,040,064
Colortyme	023	MEI		Signature	024
Craig	016,021	Memorex		Sony	026,035,047
Curtis-Mathes	009,016,017,023,024,055,062,073,076	MGA		Sylvania	017,024,038,062,065
Daewoo	003,004,005,006,007,008,022,054,085	Midland		Symphonic	024
DBX		Minota		Tandy	011,024
Dimensia	009	Mitsubishi		Tashiko	
Dynatech	024	Montgomery ward		Tatung	039
Electrohome	036	MTC	016,024	Teac	024,039,078
Emerson	017,018,019,022,024,029,032,036,043,050,051,056,058,066,071,074,076,077,079	Multitech	016,024,040,041	Technics	017
Fisher	011,021,027,028,052,057,067	NEC	011,023,025,039,055,070,073	Temika	
Funai	024	Optimus	015	TMK	076
GE		Panasonic	017,062,084,086	Toshiba	014,022,028,057,058
Go Video	016	Pentax	014,044	Totevision	016,018
Harman Kardon	023	Pentax Reserch+	055	Unitech	
Hitach	014,024,044,045	Philco	017,038,062,065	Vector Research	
Instant Replay	017	Philips	017,038	Victor	
JC Penney	011,014,016,017,023,025,039,044,060,062	Pioneer	014,025,042,059	Video Concepts	
JCL	011,017,023,025,039,055	Portland	053,054,061	Videosonic	
JVC		ProScan	009	Wards	
kenwood	011,023,025,039,055	Quartz	011	Yamaha	
		Quasar	017,053	Zenith	
		Radio Shack/Realistics	011,015,017,018,021,024,028,036,052,062		

Cable Box Codes

Anvision	015,016	NSC	017	Signature	054
Cable star	015,016	Oak	024,046	Sprucer	035
Eagle	015,016	Osk Sigma	024	Starcom	054
Eastm Int.		Panasonic	011,035,047,069	Stargate 2000	066
General Instrument	054	Philips	015,016,027,029,034,036,037,040,041,048,049	Sylvania	019,067
GI	012,013,023,031,032,033,038,044,075,076,077	Pioneer	026,028,052	Texscan	019,067
Hamlin	011,012,020,021,042,056	Randtek	015,016	Tocom	025,029,057,058,063
Hitachi	045,051,054	RCA	008,035,074	Unika	039,040,049
Jerrold	012,013,023,031,032,033,038,044,054,070,073	Regal	011,020,021	Universal	059,060
Macom	045,051	Regency	010,041	Viewstar	015,016,027,029,034,036,037,040,041,048,049
Magnavox	015,016,027,029,034,036,037,040,041,048,049	SA		Warner Amex	052
		Samsung	000,011,030,052,071,072	Zenith	022,050,065,069

DVD Codes

Philips	007
Proscan	008
RCA	008
Toshiba	002
Panasonic	006
Sony	004
Samsung	000

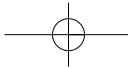

Memo

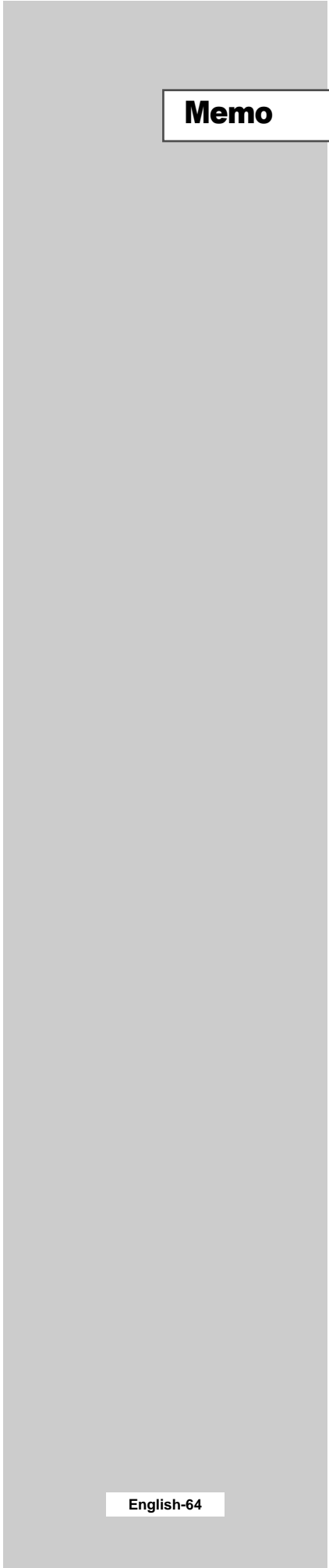

English-64

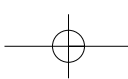
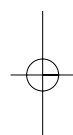
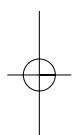

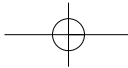

- AFTER SALES SERVICE

- Do not hesitate to contact your retailer or service agent if a change in the performance of your product indicates that a faulty condition may be present.



ELECTRONICS

